

PACK RATS'



PACK RATS

CLUB CALL: W3CCX

MT. AIRY VHF RADIO CLUB, INC.

CHEESE BITS



MT. AIRY VHF RADIO CLUB, INC., PHILADELPHIA, PA. ARNS
50.125, 144.150, 432.110, 1296.025 Mhz, WR3ACD - Repeater 222.98/224.58 Mhz
Affiliated Club: AMERICAN RADIO RELAY LEAGUE
Meetings: Third Thursday of each month at 8:00 P.M.
Southampton Free Library, 947 E. Street Road
Southampton, Pennsylvania 18966

SCANNED TO PDF BY BERT, K3IUV, 2012

VOLUME XXI

NOVEMBER, 1979

NUMBER 11

THE PREZ SEZ

With the Hamarama and VHF Conference once again a resounding success and safely under our belts for another year, the next big club event is the January VHF Sweepstakes. This Contest is always the culmination of a great deal of work on the part of many club members. Sometimes, in the confusion, I think we lose track of what the Contest is all about. Looking over some of the CAC mailings in the last year or so, I get the feeling that some people believe the sole reason for the existence of Contests is to have the rules be interpreted in such a way that everyone gets the largest possible score, by whatever means. Imagine, an event, in which the means of judging is offered as justification for its' existence. Sound confusing? Consider this example. We've heard it said many times: "If they do away with contesting on .52 in our part of the country there just wouldn't be a contest here," or something to the effect that scores would be only a fraction of what they could be if the rules were changed or interpreted in a particular way. In other words, we put a value on the numerical value of the score above that of accomplishing what the contest was designed for in the first place. In the case of VHF contests the original plan was, I think, to encourage operation on a sparsely populated portion of our radio spectrum, encourage experimentation on the "frontier" frequencies and advancement of the state of the art, and to improve operating skills. These original intentions are hard to reconcile with the fact that it takes a great deal of skill to operate on 146.52 when there are "Jammers" on the frequency!! I am not against competition. Quite the contrary - I thrive on it and I think a competitive environment is a healthy one for improving operating skills and stimulating activity and improvement of our equipment. But lets' first define our goals and then create a contest that furthers these goals - not one that obscures them!! To be a little more specific, I don't believe contests VHF, HF, DX, any contests were intended to promote working large volumes of non-contest stations who could care less about the contest and in many cases are very much inconvenienced by the whole affair. This seems to be what is happening too because the ratio of stations appearing in contest logs versus logs submitted is growing rapidly, especially on the bands where operation on the FM simplex calling frequency is prevalent. This type of "shooting fish in a barrel" operation does nothing for promoting activity on the bands - these stations would be there anyway; if anything it keeps interested contesters off the lesser populated areas of the band because all the "action" is on the national calling frequency. I doubt if it encourages experimentation and advancing the state of the art and its' not even much fun (after all-contests are supposed to be fun, right?). Those who think operation which encourages "jamming" is fun have a pretty perverted sense of whats' enjoyable! Lets' stop counting scores and get the contest back to what it was intended to do. Then the winner in each section or area had the best equipment or operating skill(or best luck sometimes). Then we will be creating a healthy environment for working greater distances on higher frequencies and really improving operation on VHF, UHF and higher.

Pack Rats CHEESE BITS is a publication of THE MT. AIRY VHF RADIO CLUB, INC. Philadelphia, Pa. and is published monthly.

Subscription Rate - \$2.00 per year.

We operate on an exchange basis with other publications. Anything that is printed in CHEESE BITS may be reprinted, unless otherwise stated, provided that proper credit is given

SWAP SHOP ITEMS - no charge.

DEADLINE FOR ARTICLES IS THE GENERAL MEMBERSHIP MEETING.

EDITOR:

W3CL, Harry B. Stein
2087 Parkdale Avenue
Glenside, Pa. 19038
215 - 887-5052

PUBLISHER/SUBSCRIPTION MANAGER:

K3GAS, Doc Cutler
7815 New Second Street
Elkins Park, Pa. 19117
215 - ME 5-1078

PRINTER:

WA3FOF, Ralph Alexander
2600 Cheltenham Avenue
Philadelphia, Pa. 19150
215-276-4185

TYPIST:

WA3TEM, Marsha Lissauer

TRUSTEE OF CLUB CALLS: W3CCX-WR3ACD:

WA3AXV, Ronald Whitsel
209 Frog Hollow Road
Churchville, Pa. 18966
215-355-5730

AWARDS CHAIRMAN:

W2EIF, Joseph Kilgore
#5 Sunnybrook Court
Stratford, N.J. 08084
609-783-9478

CLUB HISTORIAN:

W3CL, Harry B. Stein

OFFICERS: 1979-1980

PRESIDENT: W3HQT, Bill Olson
VICE-PRES: W3IIT, Harry Brown
COR. SECY: WB3HHO, Paul Randolph
REC. SECY: K3IGX, Dick Boyle
TREASURER: K3GAS, Doc Cutler

DIRECTORS:

W3HMU, Tony Souza (Ex-Officio)
N3AHI, Jim Holt (2 years)
WA3NFV, Dan Mitten (2 years)
WA3JUF, Dave Mascaro (1 year)
WA3WAS, Steve Simon (1 year)

* * *

MONDAY NIGHT NETS:

7:30 PM - 144.2 Mhz AM/FM/SSB
8:30 PM - 50.2 Mhz AM/SSB
9:00 PM - 222.98/224.58 Mhz FM
9:15 PM - 1296.3 Mhz CW
9:30 PM - 432.1 Mhz CW/SSB

NET CONTROL

W2EIF
W3CL
K3GAS
W2EIF
K3IUU

PACK RAT REPEATER - WR3ACD - 222.98/224.58
Churchville, Pa.

1-802-478-2757

AMATEUR
and
ADVANCED
COMMUNICATIONS

"Gisele"
K3WAJ

G. B. WALLS

3208 CONCORD PIKE (RT. 202)
WILMINGTON, DEL. 19803



PENNSYLVANIA
INSTITUTE of TECHNOLOGY

PAUL D. MERCADO - W3FBF
FCC AMATEUR Instructor COMMERCIAL
LICENSE INSTRUCTION

(215) FL 2-7100
(215) JA 8-6998

414 SANSOM STREET
UPPER DARBY, PA. 19082

MAKE A GOOD MARRIAGE GREAT!

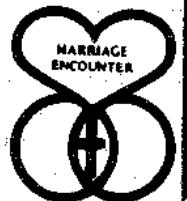

ASK US ABOUT OUR WEEKEND.

TONY AND JAN DOUG AND WENDY
W3HMU W3B3ES
HARRY AND ROSE DAN AND LUCY
W3IIT WA3NFV

CALENDAR OF COMING EVENTS
Syllabus by Lee, K3MXX

NOVEMBER

- 3 WARA Banquet - Warrington Motor Lodge
- 3-4 ARRL-Sweepstakes - CW - see October QST - Page 96
- 6 Election Day - "Throw the bums out" - be sure and vote your preferences.....
- 8 Board of Directors Meeting - QTH - W3CJU - Don Hampton
500 East Court Street
Doylestown, Pa.
If lost - 348-8969
Directors and interested parties always invited.
- 11 4x4 net group meeting at 1 PM. Klein Branch, JYC (NE PHILA.)
- 11 Veteran's Day - Thats right, it used to be called Armistice Day until 1954.
- 11 RF Hill - Winter Hamfest - National Guard Armory, Sellersville, Pa.
- 14 Eat Popcorn
- 14 Delaware Valley Chapter, QCWA - Dinner Meeting 7 P.M. Buck Hotel
- 15 General Club Meeting - Southampton Free Library, Street Road, Southampton, Pa. 8 PM
Two Meter Transverter Nite: Randy, WB2SZK will discuss transverter theory - help with your kits - building instructions, tune up info. The Mario Raffle, Frankies Silent Auction, Refreshments. An open meeting to one and all. Bring your buddies.
- 15 Pike discovers his Peak 1806
- 17-18 ARRL Sweepstakes, Phone - See October QST, Page 96
- 17 Suez Canal Opens 1896
- 19 Apollo 12 lands on the Moon 1969
- 22 Thanksgiving Day, Easy on the seconds and thirds
- 22 President John Kennedy Assassinated 1963
- 24-25 CQ World Wide Sweepstakes - CW
- 25 Cara-Fest 79 - Elliott City Armory, Maryland
- 25 DAFG Short Contest - VHF

General Club Meeting for the Next Three Months
December - Contest Preparations
January - Crying Towel
February - Home Brew Nite

Voted to Membership
W3TSE, William Letvenko,
XYL, Mary. 59 Pine Valley
Road, Doylestown, Pa. 18901
215-348-8933

(THE PREZ SEZ CONTINUED)

* * *

If a contest station had the choice between building a 2 meter or 220 FM kilowatt or building up a 2304 station - which do YOU think would be in the best interest of VHFing?? More next month!

Thanks to Jack, W2AXU for his interesting and informative talk on our friend the SUN at the Oct. meeting. The Nov. meeting will be an introduction to solid state VHF transverters and should be a must for all club members. Put it on your calendar and by the way, speaking of calendars, its almost Nov. - Still some good weather for antenna work-need help? Just ask! See you Nov. 15th.

73, Bill, W3HQT

NEW PRODUCTS OF INTEREST TO HAMS

By Lyn, W3NSI

1. REMOTE COAX SWITCH: Heath Kit has just introduced a remote control coax switch which can be mounted up on the mast, and used to switch between 5 antennas and one feed line down to the ham shack. The SA 1480 is rated at 1 KW up thru 150 Mhz. The switch box is protected from the weather, and the switch contacts are silver plated. A sixth switch position is a ground which helps keep static charges out of the station. The price of four coax leads would pay for this item. Price \$85.00

2. WIDE BAND PREAMP: Pagel Electronics is now selling the PM-5 which covers from 1 to 1000 Mhz. Gain is rated at 30 Db up to 500 Mhz and 15 Db up to 1000 Mhz. BNC coax fittings are used for the in and out connections and DC can be anything from 7-15 Volts. Power adaptor is provided. A unit like this can make the difference in a low sensitivity older counter. Price \$60. 6742C Tampa Avenue, Reseda, Ca. 91335

3. TWO METER BEAM: Cushcraft is selling their new A32-19 nineteen element beam. This unit is rated at 16.2 Db gain, and all hardware is stainless steel. Feed system includes a 4:1 balun to use with 50 ohm coax, providing a 1.2/1 SWR over the 144-146 range. Front to back ratio is 24 Db. Boomlength is 22 feet. Weight is 12 pounds. Price \$90. 48 Perimeter Road, P.O. Box 4680, Manchester, N.H. 03108.

* * *

VHF-UHF REPORT

By Jo, W2EIF

The VHF/UHF bands have been very quiet since the September QSO Party. Activity seems to have dropped off on all bands. Some of this may be due to the peaking of sporting activities at this time of year - Baseball playoffs and the inauguration of the football season with the Monday nite games and finally the World Series.

There have been reports of contacts on six meters - like Alaska to Japan and here on the East Coast, a report that the BBC TV was being copied at 48 Mhz as of mid October. Let us hope that this is heralding the advent of the expected F2 season that so many have predicted for six meters this fall.

NOTE: After Jo filed this report 6 meters opened up on Saturday and Sunday morning (Oct. 20 & 21) with a number of Pack-Rats working Europe cross band. (6-10 meters) Some 6 meter direct contacts were also made.

A note reference the 1296 Mhz Loop Yagi
Amateurs planning to build the 1296 Mhz loop yagi antenna described by W3CXU at the October 6th VHF Conference may be able to obtain the driven element hardware and the 3/8 In. wide aluminum straps for the elements at a very low cost. Contact W3CXU at 215-886-4109.

* * *

VISITORS AT THE OCT. 18, 1979 MEETING

K3KDF - Bud Smyth, Phila., Pa.

WB3EFO - Ed Lees, Huntingdon Valley, Pa.

K3KOH - Tony Millard, Phila., Pa.

* * *

TRANSVERTER PROJECT NOTICE

Randy Bynum, WB2SZK, advises that those who are on the list for the transverter kits must be present at the Nov. 15th meeting when their units will be available. If you are unable to attend, have one of the members pick up your kit. The cost is not expected to exceed \$50.00.

Thanks to Harry Brown, W3IIT, for the PC board preparation and to K3ACR, Rich Pattison for the fine schematic repros.

* * *

NOTICE

Chaverim (4x4 Net) of Greater Philadelphia, Bagels and Lox Brunch, JYC, Klein Branch. Red Lion Road and Jamison Street in N.E. Phila. Sunday, Nov. 11th at 1:00 P.M. Have an eye-ball with the Chaverim from Perth Amboy, N.J. For further info. and reservations Contact: Al, W3AYJ/ Jay, WA3IFY/ Sam, W3CYH on Tuesdays at 9:00 PM on 146.685 or call RA 5-2869/289-4531/ 969-8916.

144 MHZ SOLID STATE TRANSVERTER (Part II)

By Randy Bynum, WB2SZK

Part I appeared in the October issue of Cheese-Bits which described the receive converter and local oscillator of the 28 to 144 Mhz solid state transverter. Part II contains the transmitting mixer and a series of linear amplifiers up to approximately the 5 - 8 watt level.

As in the receive converter I used a double balanced mixer instead of an active mixer. The input to the mixer must be in the .5 to 1mw range for low IMD characteristics. A built-in 10db attenuator provides a good 50 ohm termination to the mixer which also increases the 28 Mhz input requirement to the 5 to 10mw level. An external 50 ohm attenuator will be required to limit the SSB or CW signal level to the 5 - 10mw required for proper operation. The 28 Mhz SSB is fed into the RF port and the 116 Mhz to the LO port of the DBM.

The output of the DBM (IF port) is capacitively coupled to a 2N3563 class A amplifier. This in turn drives another class A amplifier, a 2N4427. Another 2N4427 is used to further amplify the 144 Mhz signal to about 500mw level which is required to drive the 2N6081 output stage. The second 2N4427 operates close to class B operation to limit the average dissipation level to a safe amount. The output stage operates class AB with an efficiency of about 50%. The 2N6081 is forward biased into AB by means of an adjustable resistor and a silicon diode. The silicon diode is mounted to the stud of the 2N6081 to prevent thermal runaway by automatically adjusting the forward bias voltage relative to the device temperature. The higher the temperature the lower the applied bias voltage.

This two part article has only very briefly covered the transverter and if any further information is needed the author will answer specific questions upon receipt of an SASE.

As time permits I have a two stage linear amplifier planned that will take the 5 - 8 watts from the transverter up to the 60 - 70 watt level also all solid state.

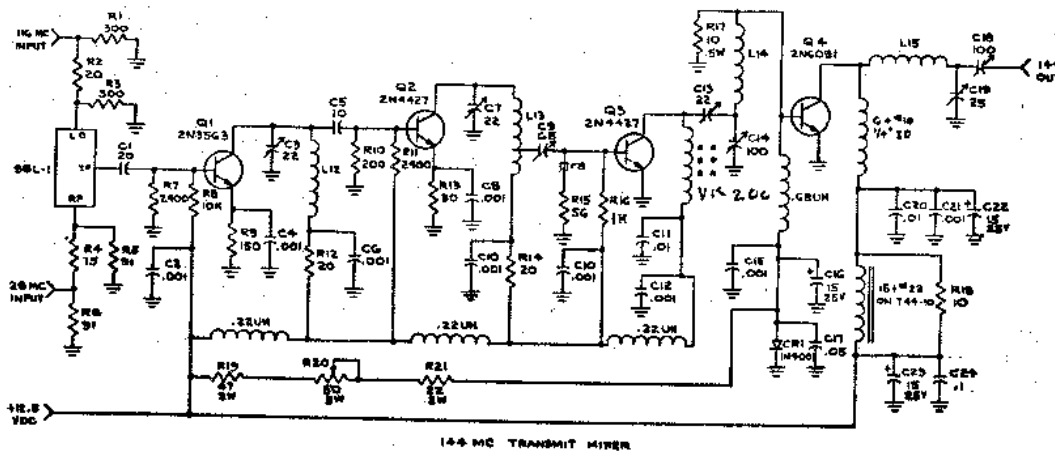

COIL TABLE

- L12 - 5 turns #18 - 1/4in. ID
- L13 - 5 turns #18 - 1/4in. ID
tap 1-1/2 turns from low end
for C9
- L14 - copper strap - 1/8in. W. x 1-1/4in. Lg.
- L15 - 3 turns #18 - 1/4in. ID



HAMARAMA

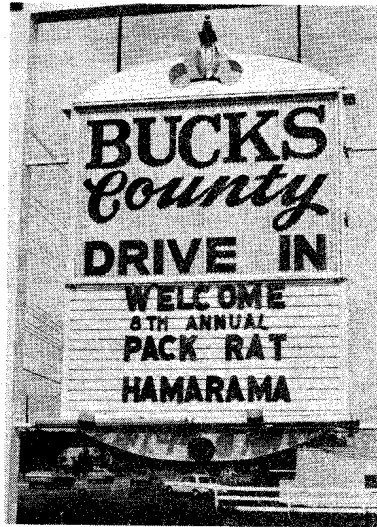

SWAP SHOP

FOR SALE: Tempo CL 220 FM - 4 Pair xtals
includes Pack-Rat Rptr. \$150. Drake TR-6
and AC 4 - \$600. Drake TC-2, SC-2, etc. \$400

CONTACT: Ron, WA1NGR/3
Phone: 301-754-8959

FOR SALE: 8 track tapes prerecorded, records,
cassette tapes prerecorded and blank,
phonographs, audio cables, receivers, mobile
antennas, new parts, chimney mounts, bumper
mounts, etc.

CONTACT: Doc, K3GAS
Phone: 215-635-1078

WANTED: Power transformer - for 3000
volts, 500 Ma. output.

CONTACT: Dick Pierce, K3MWV
Phone: 215-785-0058

FOR SALE: Kenwood TS600, Lunar 120W 6 mtr Amp.
Kenwood TS820S, Kenwood TS502S 2 mtr trsvrtr
Kenwood TS520S VFO. Ready to deal or trade.

CONTACT: Dan, N2ASE
Phone: 609-386-1540

FOR SALE: G.E. Master Pro - low band, high
split 100 w. with P.L. and acc. Heathkit
SB300/SB400. Receiver with all filters;
xmitter with xtal deck. Package with Mic. &
manuals.

CONTACT: Bruce Loss
Work Phone No. 215-657-4230 Ext. 48
or 30

WANTED: 2 - G.R. Stephen (K1FO) VHF
linear amplifiers Models 1A- any frequency.

CONTACT: John Allen, W3CXU
Phone: 215-886-4109

Thurs. & Fri. 6:30 - 10 PM/Sat. 10AM - 6 PM
F&C SALES CO. Surplus Electronics
Test equipment, Scopes, Volt Meters,
Power Supplies, All Types of Electronic
Components, Transistors, Diodes, Tubes,
Wire, Any Many Other Specials
906 W. Kings Hwy., Haddon Heights, N.J.
08035

* * *

JOTTINGS BY LEE

To get maxium attention, it's hard to beat a good big mistake.

Some people moonlight, just to see Daylight.

Statistics show that the best time to buy anything is about 40 years ago.

Bacteria is not the back entrance to a cafeteria.

What with the winter season coming on, we will be hearing a lot of the word Virus. In case you are interested VIRUS - is a Latin word used by Doctors to mean "Your guess is as good as mine."

* * *

SPACE NET VHF CONTEST

From 6 PM December 15th to 9 PM December 16th, 1979 to welcome the Space Shuttle. Contest rules the same as Apollo II - 50 Mhz up. Power categories class I, II, III, IV and YL class V will prevail. Trophies will be presented to the highest score in each class. Logs to be mailed by December 31, 1979 to: VHF SPACE CENTER, BOX 15, SUMTERVILLE, FL. 33585

* * *

TID BITS

K3KTY, John Tate, is the most traveled member of the club - received a card from Detroit the other day and now he and the family are off to Nashville, Tenn. for a bit of country music.

K1LOM made an astute observation at the Pack-Rat hospitality suite during the VHF Conference "The King is on the throne! (The war cry for the January VHF SS is "Lets Beat the King")

Jack Power, W2AXU our sun spotter reports the Zurich Sunspot number for September 1979 was 188.7 - the smooth number for February 1979 was 130.4.

If you care to monitor for openings on the 6 meter band tune to 49.250 Mhz for TV signals from France. (W2AXU reports)

We were happy to see Gordon, K3VYG at the last meeting looking fit.

Ed Lee, WB3EFO back from vacationing helped with the refreshments at the meeting.

Tnx. Ed.

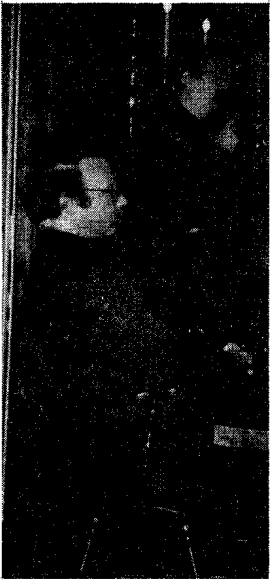

HAMARAMA CHAIRMAN
WA3AXV LISTENS TO
K3ADS ADDRESSING
THE FM FORUM

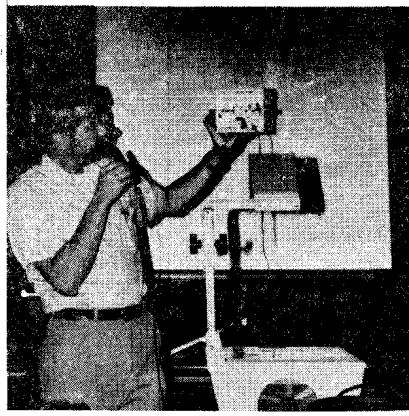

SOLID STATE UHF AMPS BY W1JR



W1JR - K3IUUV - WB2DIN/8

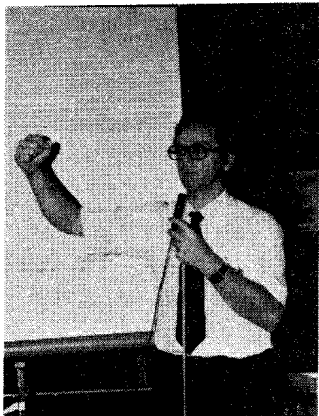

ANTENNA PATTERNS BY
COMPUTER SEZ K2RIW

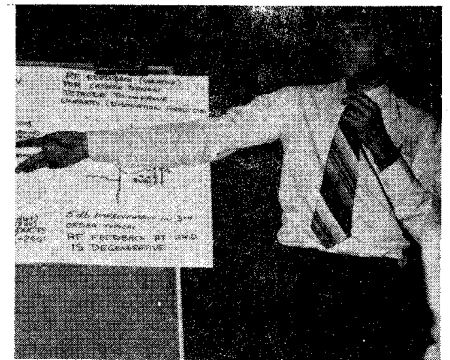
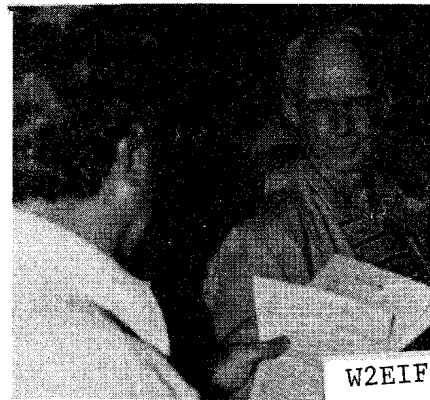

K1FO ON HI-PWR VHF AMPS.



LISTENING INTENTLY



CONFERENCE CHAIRMAN W3ZD



W3CXU DEMONSTRATES HIS 1296 RING YAGI



ANTENNA AND PROPAGATION FORUM
FROM THE LEFT - K2RIW, K1FO, W1JR AND K3PDP

MID-ATLANTIC STATES VHF CONFERENCE

Photos by W3HMU

1979 MID-ATLANTIC STATES VHF CONFERENCE

By Dave Zimmerman

W3ZD

The third annual Mid-Atlantic States VHF Conference was held on Oct. 16, 1979 at the Warrington Motor Lodge in Warrington, Pa. This event, sponsored by the "Packrats", hosted a total of 127 registrants, an increase of more than 30 percent over a year ago.

The technical sessions for the Conference featured well renowned speakers from the East Coast. First event was an FM forum moderated by Larry Will, K3ADS, the ARRL area repeater coordinator for the Third District. Larry spoke of his many experiences from his years as coordinator, gave a slide show of his 1296 Mhz repeater, and moderated a discussion among other area repeater operators including Ron Whitsel, WA3AXV who operates the Packrat 220 Mhz repeater.

Steve Powlishen, K1FO gave a slide talk on high power VHF and UHF amplifiers; gave excellent hints on the care and feeding of various configurations, and showed some samples of his work. Steve has published articles on amplifier construction in QST and other mags, and has many examples of his design on the air.

Following a very excellent buffet type lunch, Joe Reisert, W1JR lectured on solid state UHF amplifiers. Several very inovative features were presented to the conference, and several samples of Joe's very excellent handiwork were shown.

Dick Knadle, K2RIW, presented his recent findings on plotting of antenna patterns by computer using programs written by him. The work currently being done by Dick follows several years of concentrated effort to solve the mysteries of the Yagi antenna, and when finished will no doubt appear in print in the form of a text on the subject. The antenna patterns shown by Dick in some cases represented as much as twelve hours of computer and plotting time. The detailed artistry of the sketches was amazing and provided the VHF group with some new insight into the Yagi.

The VHF Conference ended with an antenna forum moderated by Walt Bohlman, K3BPP with the panel made up of all the above speakers and a few from the local area. Walt Bohlman has been a dedicated experimenter, and is considered to be an authority on the feeding of large dish type antennas, and was one of the members of the Packrats moonbounce expedition to Colombia, SA in 1976. John Allen, W3CXU gave a description of his improved long-ring antenna for 1296 Mhz which has proved to be so successful for DX work.

An evening cocktail party hosted by the Packrats followed by a buffet dinner attended by 85 attendees and their XYL's topped off the event. Many thanks to Doc, K3GAS for his dedicated manning of the registration desk.

* * *

HAMARAMA REPORT

By Harry, W3CL

The 1979 Hamarama Flea Market under the expert direction of Ron Whitsel, WA3AXV went off without a hitch.

Over 2000 were in attendance with 1800 paid admissions including 275 sellers. Rain in the morning came as predicted stopping at 9:15 AM, 25 minutes off Doc's (K3GAS) crystal ball; he was more accurate last year with the error being 10 minutes off the mark.

Participation by the Pack-Rats and their ladies was again outstanding. Jim Holt's (N3AHI) ticket sellers and Steve Simons' (WA3WAS) parking group performed their jobs smooth as silk. Registration and ticket selling by the ladies was handled so precisely that the registration chairman was able to spend the bulk of the day handling announcements on the Philmont Mobile Radio Club amplifier. Coverage of the area was excellent. Many thanks to the Philmonters Jim & Ric Spencer, W3BBB. Thanks to the following girls for their dedicated efforts: Rose Brown, Peggy Cohen, Loretta Cutler, May Gakoumis, Ann Gardocki, Bert Kenas, Lucy Mitten, Wendy Simpson, Sylvia Stein, and Lynne Whitsel.

The raffle prize, a Bearcat Scanner, was won by Bob Seeland, KA2AOG of Franklin Park, N.J.

Space Net

VHF CONTEST

6PM, DECEMBER 15, 16, 1979, 9PM.

... Welcome ...

SPACE SHUTTLE



PACK-RATS THAT PARTICIPATED IN THE APOLLO II SPACE NET CONTEST RECEIVED CERTIFICATES AND A PLAQUE. FROM LEFT - HARRY, W3CL, RICH, K3ACR, GORDON, K3VYG. JOE, W3YXF WAS NOT PRESENT FOR THE PICTURE TAKING.

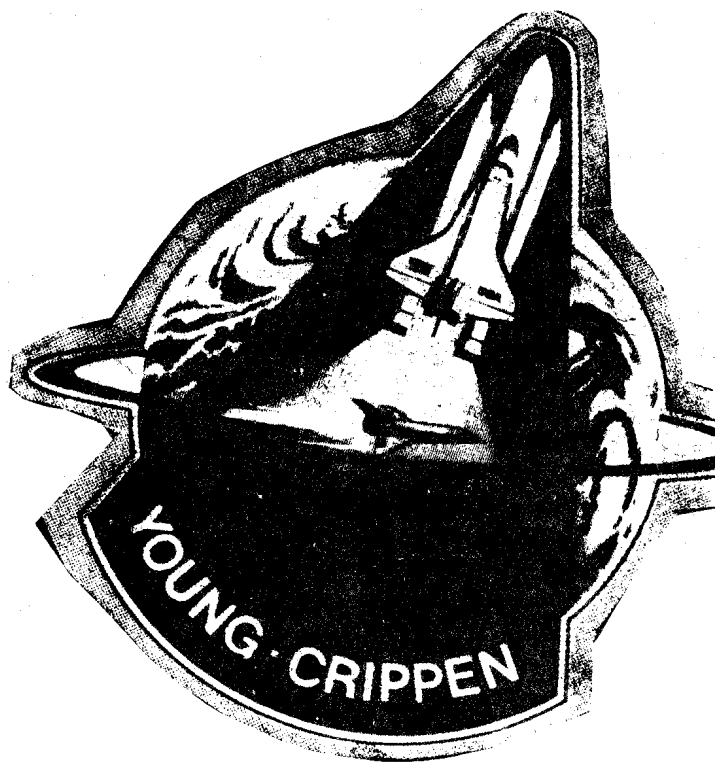

CONTEST RULES SAME AS APOLLO

Power Categories Class I, II, III, IV, and XYL will prevail and Trophies will be presented to highest score in each Class.

Mail logs by Dec. 31.

VHF SPACE CENTER

Box 15, Sumterville, Fla. 33585

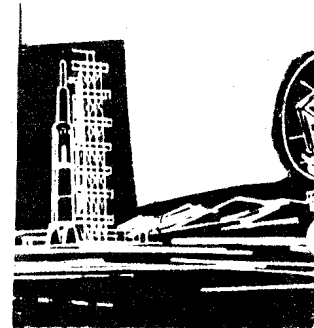
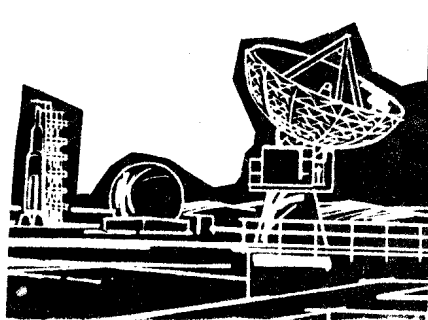

215-947-6670

MARKETLINE™

SYSTEMS, INC.
2337 Philmont Avenue
Huntingdon Valley, Pa. 19008
Computers for Hobbyists



AMERICAN RADIO RELAY LEAGUE

HARRY A. McCONAGHY, W3SW/W3EPC
DIRECTOR, ATLANTIC DIVISION

8708 FENWAY DRIVE - POTOMAC
BETHESDA, MARYLAND, 20034

NE 7-8329

GEORGE S. VAN DYKE, JR., P.E.
CONSULTING ENGINEER

W3HK

4607 CONVENT LANE
PHILA., PA. 19114



AMIL S. GUMMIA
PRESIDENT

A. G. RADIO PARTS CO.
939 TOWNSHIP LINE RD.
ELKINS PARK, PENNA. 19117
TELEPHONE: 215-803-5100

RCA Authorized
Distributor

HOURS
CLOSED MONDAY
TUE. & THUR. 9:30-5:00
WED. & FRI. 11:30-5:00
SAT. 9:30-5:00

(215) 723-1200
(215) MI 6-2511

ELECTRONIC EXCHANGE

ALL TYPES OF HAM GEAR & ELECTRONIC EQUIPMENT
BOUGHT, SOLD, TRADED & REPAIRED

GORDON R. KITTEL
W3GK

196 N. MAIN STREET
SOUDERTON, PA. 19364

AMATEUR & CB RADIO
SALES & SERVICE (215) OL 9-5900

"HAM" BUERGER INC.
Communication Specialists

BOB HERSHMAN
WA3ZID 68 N. YORK RD.
WILLOW GROVE, PA. 19090

Fine Printing For The Radio Amateur
Custom Printed QSL Cards Since 1969

K2RPZ PRINT

stu goodman

Birth-Wedding & Bar Mitzvah Invitations
Raffle Books-Rubber Stamps-Tickets-Bumper Stickers
Business Cards-Letterheads-Envelopes

(516) 744-6260

P.O. BOX 412
ROCKY POINT, N.Y. 11778

Write for FREE
COPY of any of
our publications.

The Ham Radio Publishing Group
GREENVILLE, NEW HAMPSHIRE 03048

Exit I-95 at Scotch Rd. South
Al & Hank (WB2GWE)



the BARGAIN BROTHERS
PHOTO & ELECTRONIC SURPLUS

CONSTANTLY CHANGING INVENTORY · LOWEST PRICES

Glen Roc Shopping Center
216 Scotch Road
Trenton, N.J. 08618

(609) 883-2050

K3KEY

215-567-7130

TRANSPORT EQUIPMENT COMPANY

"EVERYTHING FOR THE TRUCK"

JOHN A. TATE
President

2215 - 2217 Race Street
Philadelphia, Pa. 19103

K3MWV

THE KENRICH CORPORATION ELECTRONICS

RICHARD H. PIERCE
VICE PRESIDENT

P. O. BOX 652
LANGHORNE, PA. 19047
(215) 946-4989

BROWNS - THURS. 7⁰⁰ - 8⁰⁰ AM
SAT. 8⁰⁰ - 4⁰⁰ AM

Day-Nite (215) 455-2121

FERTIK'S ELECTRONICS

Components & Equipment

LEON FERTIK

5400 ELLA STREET
PHILADELPHIA, PA. 19120

CAR STEREO - CITIZENS BAND - BURGLAR ALARMS
2 WAY RADIO - TOWER INSTALLATION & REMOVAL
TV - HAM - CB ANTENNAS

Steve Simons

MOBILE EQUIPMENT INSTALLATIONS
SALES & SERVICE

WA3WAS

TEL. (215) RA 5-1135

8506 KENDRICK PL.
PHILA., PA. 19111

215-276-4185

WA3FOP

RALPH ALEXANDER

Electronic Equipment Repair
Technical Writing
Printing

(215) RE 9-8616

City Communication Center

Amateur - Commercial - Marine

BUY SELL TRADE

Sales - Service - Installations

Joe - WB3GEL
Tony - K3UKW

2823 Kensington Avenue
Philadelphia, Pa. 19134

People who look for peace get it.

-Guru Maharaj Ji

For information contact:

DIVINE LIGHT MISSION (DUO)
6037 Overbrook Ave.
Phila., Pa. 19131
Office: 215- GR 7-2800



73 magazine
for radio amateurs

PETERBOROUGH, NEW HAMPSHIRE 03458

1 Year = \$18
3 Years = \$36

RESIDENTIAL

COMMERCIAL

SHAVNEY LANDSCAPING

DIVISION - SHAVCO, INC.
111 S. EASTON ROAD
GLENSIDE, PA. 19038

PETER H. SHAVNEY, WA3OVH

886-1859

