

PACK RATS'



PACK RATS

CLUB CALL: W3CCX

MT. AIRY VHF RADIO CLUB, INC.

CHEESE BITS



MT. AIRY VHF RADIO CLUB, INC., PHILADELPHIA, PENNSYLVANIA ARNS
50.125, 144.150, 220.125, 432.110, 1296.110 Mhz, W3CCX - Repeater 222.98/224.58 Mhz
Affiliated Club: AMERICAN RADIO RELAY LEAGUE
Meetings: Third Thursday of each month at 8:00 P.M.
Southampton Free Library, 947 E. Street Road
Southampton, Pennsylvania 19866

VOLUME XXVI

NOVEMBER, 1984

NUMBER 11

THE PREZ SEZ

Well, the Pack-Rats did it again. What a weekend we had with the VHF Conference and HAMARAMA. Those who were there had a great time meeting old and making new friends. The speakers were outstanding and HAMARAMA was a success too. We had some parking problems but with the help of everyone, things worked out. I believe everyone ended up the day finding everything they were looking for.

Thanks again to Gary, WA2OMY, Conference Chairman, and Lee, K3MXM, HAMARAMA Director, for their hard work in making another successful weekend. Thanks to all the members' wives and friends who helped to make the events the best to date.

Now... January is just around the corner. Rick, WB2NPE and Bob, N2SB, VHF SS Contest Co-Chairmen, have already started working hard to get things going for this contest. The opening outstanding talks that Rick and Bob gave at the October meeting were just the first they will give to help us understand the changes made in the rules for this contest.

If you were not at the October meeting, you missed an outstanding talk and demonstration on Packet Radio. It was very interesting and informative. Some of the Pack-Rats may have found a new hobby within an old one. Many thanks to Jon Pearce, WB2 MNF, and Joe Fisher, KC2TN for a job well done.

Hope to see you all at the November meeting... Time for HOLIDAY GREETINGS ... Bring a buck and an artists pen.

73,

Dave, WB2VLA

Pack Rats CHEESE BITS is a publication of THE MT. AIRY VHF RADIO CLUB, INC. Philadelphia, Pa. and is published monthly.

SUBSCRIPTION RATE - \$2.50 PER YEAR

We operate on an exchange basis with other publications. Anything that is printed in CHEESE BITS may be reprinted, unless otherwise stated, provided that proper credit is given.

SWAP SHOP ITEMS - NO CHARGE

DEADLINE FOR ARTICLES IS THE GENERAL MEMBERSHIP MEETING: THE THIRD THURSDAY OF THE MONTH.

EDITOR:

W3CL, HARRY B. STEIN
2087 Parkdale Avenue
Glenside, Pa. 19038
215-887-5052

PUBLISHER/SUBSCRIPTION MANAGER:

K3GAS, DOC CUTLER
7815 New Second Street
Elkins Park, Pa. 19117
215-635-1078

PRINTER:

WB2VLA, DAVID POWER
609-882-1040

TYPIST:

WA3TEM, MARSHA LISSAUER

TRUSTEE OF THE CLUB CALL - W3CCX:

WA3AXV, RONALD WHITSEL
215-355-5730

AWARDS CHAIRMAN:

W2EIF, JOSEPH KILGORE
609-783-9478

CLUB HISTORIAN:

W3CL, HARRY B. STEIN

MONDAY NIGHT NETS

	<u>NET CONTROL</u>
7:30 PM - 50.125 MHZ	W3CL
8:00 PM - 144.150 MHZ	W2EIF
8:30 PM - 222.98/224.58 MHZ	K3GAS
8:45 PM - 220.125 MHZ	KS2T
9:00 PM - 432.110 MHZ	K3IUUV-NF2L
9:30 PM - 1296.1 MHZ	W3HQT

PACK RAT REPEATER 222.98/224.58 MHZ/W3CCX
LOCATED IN CHURCHVILLE, PA.

OFFICERS: 1984-1985

PRESIDENT: WB2VLA, DAVE POWER
VICE-PRES: WB2RVX, MIKE GULLO
COR. SECY : AK30, FRANK KERNS
REC. SECY: W3IIT, HARRY BROWN
TREASURER: K3GAS, DOC CUTLER
DIRECTORS: NF2L, BILL SMITH (EX-OF)
WA3AAJ, JIM WARD (2 Yrs)
WB3IND, GEORGE McMAHON (2 Yrs)
WA2OMY, GARY HITCHNER (1 Yr)
WA3YUE, BRUCE LOSS (1 Yr)



THE AMERICAN RADIO RELAY LEAGUE

QST

HUGH A. TURNBULL, W3ABC
Director, Atlantic Division

6903 RHODE ISLAND AVE.
COLLEGE PARK, MD. 20740

(301) 927-1797

1-302-478-2757

AMATEUR
and
ADVANCED
COMMUNICATIONS



G. B. WALLS

3208 CONCORD PIKE (RT. 202)
WILMINGTON, DEL. 19803



Pennsylvania Institute
of Technology

PAUL D. MERCADO
Chairperson, Drafting Design Department

(215) 565-7900

Rose Valley-Notre Dame Campus
800 Manchester Ave., Media, Pa. 19063-4098

FREE ESTIMATES
(215) 672-3850
(215) 822-0808



MICHAEL McMACKIN

REGISTERED PLUMBING & HEATING
BATHROOM INSTALLATIONS * ELECTRIC DRAIN CLEANING

96 HELLBERG AVE.
CHALFONT, PA. 18914

2405 PARKSIDE AVE.
HATBORO, PA. 19040

CALENDAR OF COMING EVENTS

Syllabus by Lee, K3MXM

NOVEMBER

- 3 For our Western Pa. Readers: Foothills ARC 16th Annual Hamfest
Location: St. Bruno's Church, South Greensburg, Pa.
- 3-4 ARRL November Sweepstakes - CW. Info: October QST Page 77
- 4 RF Hill Hamfest - Sellersville Armory, Sellersville, Pa.
- 6 Election Day - Make your thoughts and opinions count. GET OUT AND VOTE!!!
- 10 Radio Expo '84 Hamfest - Montvale, N.J. Pascack Hills High School, Grand Ave.
and Spring Valley Rd., Montvale, N.J. Info: Robert Greenquist - 1-201-666-3902
- 11 Veteran's Day
- 15 Board of Directors Meeting. QTH: WA3AAJ, Jim Ward. 110 Lyster Road, Oreland, Pa.
If Lost: 887-1062. Directors and interested parties always welcome.
- 17-18 ARRL Sweepstakes - Phone - Rules and info. October QST Page 77
- 18 First Mickey Mouse Movie - 1928
- 19 President Lincoln gave the Gettysburg Address - 1863
- 22 Thanksgiving Day
- 22 General Club Meeting, Southampton Free Library 8:00 P.M.
Topic: To be announced on Monday Nite Nets. The Mario Raffle, Frankie's Silent
Auction, Refreshments.

NOTE: PLEASE FILL OUT YOUR CONTEST QUESTIONNAIRE AND GET IT BACK TO YOUR CAPTAIN PROMPTLY

* * *

CONTEST LOG KEEPING

A computer program for the Commodore 64 that does the check log is available thru WA3IWT. This program keeps track of the bands you worked a station on. It is fast and requires a minimum of key strokes. It will hold 450 calls. It is on disk only. I would like to thank Dave Harris of KYW-TV for his many hours writing this program for us. Send me a disk and envelope with sufficient postage and I will make you a copy. Contact: Richard Prim, WA3IWT, 105 Cherokee Drive, Richboro, Pa. 18954.

* * *

GONE TO THE DOGS

The American Kennel Club 100th Anniversary Dog Show will be held November 17 & 18 at the Philadelphia Convention Center. W3CJU, Don Hampton is in charge of internal communications. He needs a few volunteers to give a hand. If interested in a great dog show and want to give a hand, contact Don on 215-348-8969 (home) or 215-348-4884 (store)

NEW PRODUCTS OF INTEREST TO HAMS

By Lyn, W3NSI

1. 1296 TRANSVERTER: The KLM 1200 DF transverter is a two channel 5 watt output unit for use in the 1270 Mhz area for Oscar mode L and the second channel for regular 1296 use. A 2 meter rig is used for the IF frequency and input is switchable 1 or 10 watts. Noise figure is rated at 6 Db max. Current drain on transmit is 3 amps at 13.8 VDC. The 1200 is mounted in a compact box 2 1/4 x 4 1/2 x 10 deep. KLM indicates they will follow this product with a matching amplifier and preamp. KLM P.O. Box 816, Morgan Hill, CA. 95037
2. HOMEBUILT TOWER FITTINGS: Bullseye Products has a line of hardware to be used with 3/4" electrical conduit to construct a custom tower unit to fit your needs. Such a unit has the advantage of being disassembled to move to another QTH or for field day. 28506 Hayes, Roseville, MI 48066
3. HAM COMPUTER INTERFACE: The new MFJ 1229 is that companies most advanced RTTY/ASCII/AMTOR/CW interface. Features include an LED tuning indicator, RS 232 interface, variable shift tuning, and use of both wide and narrow shift RTTY. MFJ will provide free software for use with the VIC 20 and C64 computers. The 1229 can also be used with TRS, Atari, and TI94 using software from Kantronics or AEA. Price \$180.
4. ANTENNA BRIDGE: MFJ has also introduced an Antenna Bridge for use on the HF bands up to 30 Mhz. Using the MFJ 204 it is possible to find the frequency and resistance of an antenna without having to turn on the transmitter. The 204 is powered by a 9 v battery and has an output jack for use with a counter. It can also be used as a signal generator. Price \$80.

* * *

FROM ARRL LETTER 10/11/84

A "mystery satellite" has been heard on several occasions. Paul Wilson, W4HHK, of Collierville, Tennessee, says that he has heard satellite signals on 2301.0 MHz. During the two-hour period, on October 5, Wilson heard a steady carrier with Doppler shift on 2304.0 MHz. At 0212 UTC the dish heading was 52 degrees azimuth, 20.5 degrees elevation. The signals and headings were confirmed with WA4HGN. 80 miles away. W4HHK uses an 18-foot dish and WA4HGN has a 28-footer. Signals were 20-30 dB out of the noise.

The signals were heard again at 1754 UTC the same day, in the same general heading. If anyone is interested in these mysterious satellite signals, contact Wilson at Box 73, Collierville, TN 38071. Tel: 901-853-7373.

* * *

HAMARAMA REPORT

Attendance - The Best Ever - over 3000. 24 members reported for the 5 AM breakfast which included Sally Rowland and she also manned the registration desk.

Thanks to the other gals who worked the registration: Rose Brown, Jan Souza, Lorretta Cutler, Janet, KA2NYF, and Kathy, WB3LTH. 32 pack rats directed the parking and sold tickets - K3QQ's harmonics Jonathan, KA3NDF and Ian, KA3NDG helped also. Many thanks to all. The Kenwood 2600A raffle prize was won by Brett Lipshultz of Landsale, Pa. The second prize, a Dentron Multi Meter was won by WA2FXB.

* * *

SWAP SHOP

FOR SALE: Test equipment by Heathkit - 1-5 inch oscilloscope, mod. 0-8; 1- capacity meter, mod. CM-1; 1 - vacuum tube voltmeter, mod. V-6; 1 - A.C. vacuum tube voltmeter, mod. AV-2. All in good condition and operating. Each with it's manual. Meters have microampere sensitivity. Will entertain an offer for each or all.

CONTACT: Jack Power, W2AXU
Phone: 609-882-8811

FOR SALE: Amateur TV station: Good working HB camera; 2-small TV sets (monitor & receive) RCA CMU 15 xmitter, motorola T44 rcvr. 2 - MRF 901 - pre amp. All power supplies and cables for above, output meter, rcvr function meter, televerter. Literature and ATV magazines from first issue. Box of good vidicons - entire package -\$75 cash.

CONTACT: Doc Cutler, K3GAS
Phone: 215-635-1078

FOR SALE: Lafayette CB transceiver - comfone model Mark 2. 23 channels w/antenna. Best offer.

CONTACT: Molly, K3FYS
Phone: 215-969-6858

FOR SALE OR SWAP: R390A Rcvr; Robot 400 SSTV; Robot 800 - CW/RTTY/SSTV.

CONTACT: Gus, K3GYS
Phone: 609-767-3628

FOR SALE: Midland 13-509 220 Mhz rig - 10W. 16xtals w/4 local repeaters including the Pack-Rat rpttr w/manual. Excellent cond. \$165 (will negotiate)

CONTACT: W2HK, BB Wentzel

Phone: 609-393-4823

FOR SALE: Loop Yagis for 1296 - 45 e1 brand new. Ready to go. \$65. 5 watt 1296 linear \$80.

CONTACT: Bill Olson, W3HQT
Phone: 215-538-0311

FOR SALE: RCA Scope 3" W033A with leads & book. Exc. cond. \$50; Lab-Volt VOM - Model 700 Solid state. With leads & book exc. cond. \$45; Anaconic Digital VOM #390 w/book. exc. cond. 4 dig. readout. Also meas. cap. \$75; RCA TV Camera TC 1000 w/book, mount, & spare 4848 vidicon. With monitor 9" GBC MV 900 with book. Both exc. cond. \$175; ATV Research TV Camera kit w/lens and vidicon. 90% finished, w/all parts & pla \$50; Parker ATV TV Camera w/vidicon & lens 95% finished w/all parts & plans. \$45.

CONTACT: Lyn Rowland, W3NSI
Phone: Phila. 215-742-7695
Shore. 201-255-5998

COMMERCIAL AD

Chassis-kit can save the homebrewer dollars, replaceable sides, end, and top plates. Any size up to 17 inches square of .040 aluminum. For quotes on other size send SASE. Side plates 20% each of chassis price plus \$1.00 postage & handling for 1st and \$.50 for each additional. Cabinet kits quotes SASE state size and of front opening.

<u>CHASSIS-KIT</u>		<u>BOTTOM PLATE</u>		<u>CHASSIS-KIT</u>		<u>BOTTOM PLATE</u>
4x8x3	- \$4.65	\$1.80		8x17x3 3/4	- \$10.00	\$3.65
5x9x3	- 5.15	1.90		8x17x4	- 10.95	3.65
8x10x3	- 6.40	2.85		10x17x3	- 8.70	3.75
8x12x3	- 6.90	3.55		*10x17x3 3/4	- 11.95	3.75
8x12x4	- 8.50	3.55		10x17x4	- 12.95	3.75
10x14x3	- 8.40	3.65		*10x17x5	- 18.45	3.75
6x17x3	- 8.25	3.60		*8x18x3	- 8.95	3.75
8x17x3	- 8.40	3.65		*8x18x4	- 11.50	3.75

* Special Order

New single disk drive box \$10.25 plus postage and handling. Tower mounting box w/mounting plate and 4 u-bolts (.040 alum.) 8x10x3 - \$11.95 8x10x4 - \$13.50
Add \$2.50 for postage & handling for 1st chassis-kit. Add \$.85 for each additional kit and \$.50 for each bottom plate when ordered with a chassis-kit. Pa. residents add 6% sales tax. Prices can change without notice. Byers Chassis-Kit, 5120 Harmony Grove Road, Dover, Pennsylvania 17315.

The PRB'S INQUIRY into what national policy the FCC should adopt regarding local personal radio towers and antenna is in trouble. The ARRL-initiated PRB-1 asks whether states or local governments should have the authority to enact laws or ordinances prohibiting or severely restricting the erection of amateur radio antenna structures. The measure, which carries a Nov. 9 commentary cutoff date, has only elicited a smattering of responses from licensed radio amateurs. Those who oppose the basic freedom of citizens to put up antennas on their own property, on the other hand, are responding with lengthy filings.

PRB-1 may turn out to be one of the very most important matters ever considered by the FCC in the foreseeable future. If the FCC rules in the Amateur Service's favor, it could become virtually impossible for city planners to ban antennas based on esthetics. Public safety would be the singular criterion on which states, cities or other governments could legally exercise control over amateur antennas, and then only within reasonable constraints.

The inquiry into the proposal is, however, a double edged sword. If response from radio amateurs is poor or lacking in good, logical arguments, opponents of "unattractive protuberances" may finally have their day. An adverse ruling by the FCC could give some local authorities all the excuse they need to virtually legislate amateur radio out of existence in their communities. Several city planners have let it be known that they desire control over more than simply antennas; regulation of the amount of RF radiation emitted by personal transmitters is also desired.

A loss before the Commission on this measure could make the controversies over No Code, 11 meters and malicious interference of little practical significance. Radios transmitters without antennas are like cars without wheels: not much happens.

(Pub. note: While Westlink Report rarely editorializes on its front page, both Bill and I feel that this matter is extremely important. Experiences with local governing authorities who attempted to prevent your construction of an antenna structure are important evidence. Please take the time to file in favor of PRB-1. Fried Heyn (WA6WZO), Director of the Southwestern Division of ARRL and Wayne Overbeck (N6NB), its Vice-Director, have made available a sample filing and instructions on how to do it. Westlink Report will mail a copy to anyone, subscriber or not, who sends us a large self addressed, stamped envelope. DE WB6MQV

* * *

TID BITS

Sunwatcher, Jack Power, W2AXU, reports the Monthly No. for September 1984 = 15.4 Smoothed No. for March = 52.7.

West Coast Pack-Rats attended our October meeting; WB2SZK and WAIYHO.

A lot of interest in Packet Radio was shown by the members at the October meeting. Jon Pearce, WB2MNF gave an excellent talk assisted by Joe Fisher, KC2TN who was in charge of the Demo.

After an absence of 23 years, Don Lauer came to the October meeting and applied for reinstatement. His new call is KA3MGR.

* * *

NEW HAMTRONICS CATALOG

Hamtronics, Inc. announces publication of their new 1985 mail order catalog crammed full of goodies for the VHF/UHF/OSCAR enthusiast. The 40 page 2 color catalog features many new products, including a Simplex Autopatch kit, a Repeater COR with Courtesy Beep, GoAs FET Receiver Preamps, Active Antennas for Scanners, and repeater PA kits. Also included are the popular lines of FM and AM Receivers, FM transmitters, VHF and UHF Transmitting and Receiving Converters, Repeaters, Space Shuttle Receivers, 800 MHz Scanner Converters, and other products Hamtronics has long been noted for.

For your free copy of this informative new catalog, call 716-392-9430 or write to Hamtronics, Inc.; 65-F Moul Rd.; Hilton, N.Y. 14468-9535. (For overseas mailing, please send \$2 or 4 IRC's.)

VISITORS-OCTOBER 18, 1984 MEETING

KA2NYF - Janet, Voorhees, N.J.
WB3NNI - Pat Cowthorne, Warminster, Pa.
KA3MGB - Don Lauer, Kutztown, Pa.
WB8ZAR - Dave Martin, Cinnaminson, N.J.

WA3YDZ - Dave Hartrum, Springfield, Pa.
WB2MNF - Jon Pearce, Medford, N.J.
KC2TN - Joe Fisher, Atco, N.J.

VOTED TO MEMBERSHIP

N3AOG - Richard E. Comly - Janice
56 Home Road
Hatboro, Pa. 19040
215-443-9965

APPLICATION FOR REINSTATEMENT

KA3MGB - Donald Lauer
RD 4 - Box 361
Kutztown, Pa. 19530
215-683-6006

APPLICATION FOR MEMBERSHIP

WA3YDZ - Dave Hartrum
315 Butler Road
Springfield, Pa. 19064
215-328-0336

CHANGE OF ADDRESS AFTER
NOVEMBER 16, 1984

W3HQT - William Olson -XYL Sandy
RFD #1, Box 1655A
Burnham, ME 04922

WB8ZAR - David Martin
102 Erlington
Cinnaminson, N.J. 08077
609-829-6824

ANOTHER RADIO FAMILY

Dick- N3AOG, Janice- N3CFE, Jim- N3DCR,
Chris- KA3EAQ

* * *

LEE'S POTPOURRI

Golf is no longer a rich mans game - there are millions of poor players...
A golfer is a chap who yells "fore", takes a six and puts down a five.
Golf is what men do to relax when they are too tired to mow the lawn...
There are bigger things than money - bills, for instance...
International finance is the art of borrowing on the strength of what
you already owe...

Shark steak is considered to be a delicacy. In other words, despite all you've
heard, you're much more likely to see a man eating shark than a man-eating
shark...

When looking at the bank clock for the temperature, the time will always show up...
Sign now appearing in many factories: "look alive, you can be replaced by a
button."

A desk is a waste basekt with drawers.

Never meet trouble half way - it will make the whole trip if it wants to...

* * *

LAST MINUTE SWAP SHOP ITEM

FOR SALE: TEN TEC Argonaut Model 509 with P/S .. \$225; TEN TEC Model 405 Lin.Amp 100W-\$175
Heathkit HW8 with Regency P/S Model P-107 .. \$125; Collins Stn..Vy gud condx ... 32S1 Xmtr,
75S3 Rcvr, 516F2 P/S .. \$450; Collins ML31 Linear Amp...\$325; TEN TEC paddle w/four memory
keyer-"Mimic".. \$55; Dentron Super Tuner.. \$150; Pair 11el. 2 mtr beams, stacked w/tower
45 ft. & Rotator (you take down) .. \$175; Mini-Quad HQ-1 beam .. \$50; TEN TEC digital
readout for Argonaut .. \$30; Heathkit Freq. Counter #IM-4100 .. \$125; MFJ Memory Keyer.\$70
Ameco Code Practice Osc. CONTACT: Tony Musero, K3UKW - 215-271-8898 * Leave msg.& I'll
get back to you.... ..

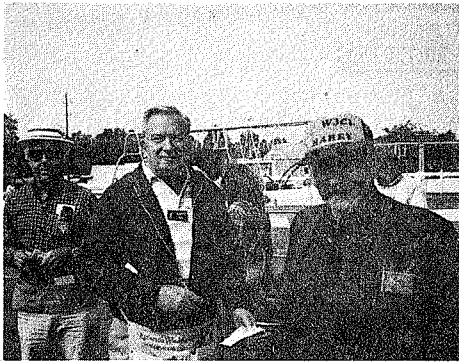

K3IUV, K3PHY - Tickets .. W3CL - Registration



FCC REP - MRS. GERTRUDE ANDERSON



K3MXM - HAMARAMA DIRECTOR



JAN, ROSE - Registration

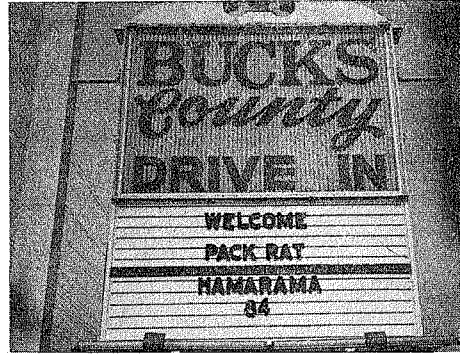

LORETTA, JAN - Registration

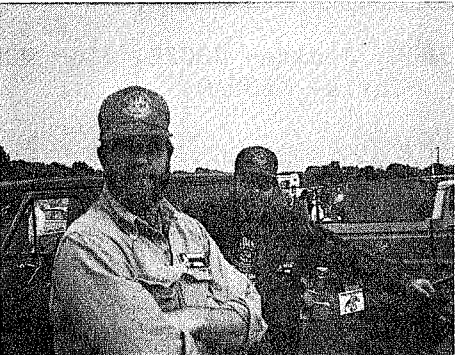

WB2NPE, N2SB - Parking (Contest Co-Chairmen)

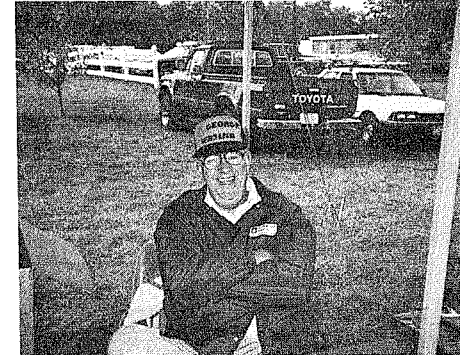

WB3IND - Parking earlier - resting

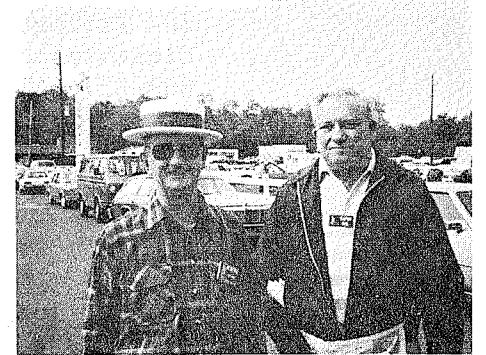

W3CXU, K3PHY - Tickets



JENNIFER, WA2OMY - Conference Chairman, W3ZD
WB2VLA - Our President



CONFERENCE SPEAKERS - W3XO, K3QCQ, W3HQT, WD4FAB,
KA9Q, WA3JUF, K8KA, K1FO in foto below.

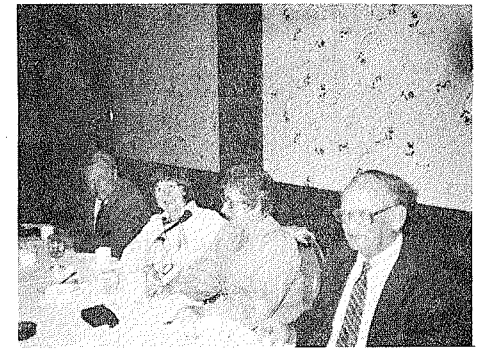

K3GAS, Loretta, PEGGY, K3MXM

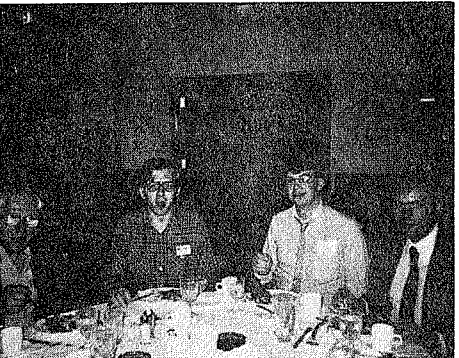

W3XO, KA9Q, K8KA, AA2Z

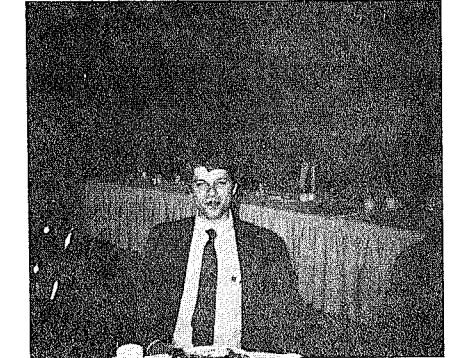

N2SB, AA2Z, K3QCQ

1296 Mhz. Amplifier
by D. Mascaro, WA3JUF

With everyone using GaASFET front ends on 1296, the MRF901 amplifier that we all built is collecting dust on the shelf. This month I'll show how to modify the 901 circuit for an SD1333 amplifier that is usable for 100 mw of SSB. Next month will be devoted to the SD1359 amp. @ 300 mw Out.

A simple modification to the amplifier described in Oct. 1975 HR magazine is shown in the schematic. A shunt capacitor on the output of the device is all that's required to make the circuit tune. Then setting up the bias for I_{cQ} of 70-80 ma. is the only other change.

The amplifier tunes fine with the two tuners, so the other trimmers on your 901 preamp can be removed. Solder a piece of copper foil or brass strip right at the output of the device. The amplifier will do 100-125 mw with >10 db gain.

1296 Amplifiers using plastic transistors (Macro X)

- | | | | |
|---|-----------------|----------------|----------------------|
| 1 | SD1331 (MRF901) | Pout 10-20 mw. | standard 901 circuit |
| 2 | SD1333 (BFR96) | Pout 125 mw. | WA3JUF design |
| 3 | SD1359 | Pout 300 mw. | WA3JUF design |

The SD1331 thru 1359 are manufactured by Thomson-CSF
These devices and others are available from:

RF Gain, Ltd.
100 Merrick Rd.
Rockville Centre, NY 11570
(516) 536-8868
800-645-2322

CB-438 (MACRO X)

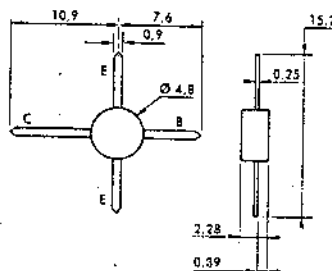

1296 Mhz. Amplifier

full sized

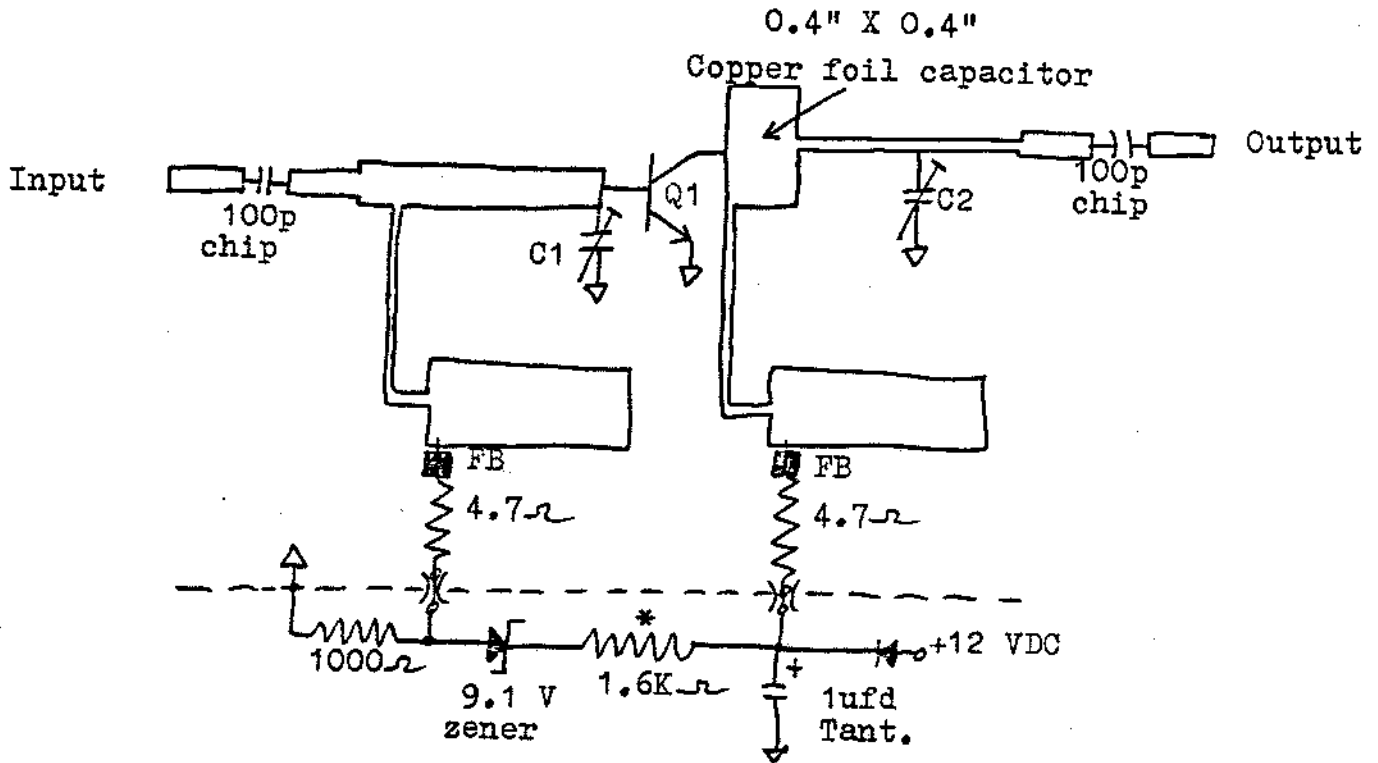
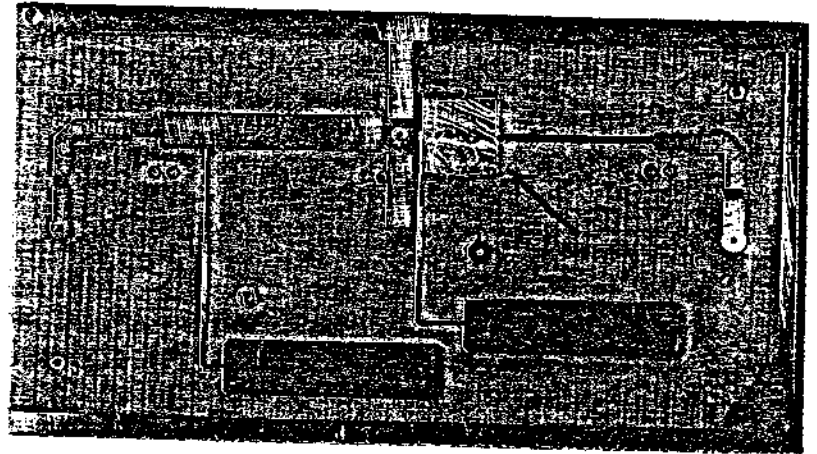

Board material 1/16" G-10 Doublesided

Q1 SD1333 or BFR96

C1 0.3-3 pf Piston trimmer

C2 5 pf piston trimmer

mount C2 halfway between foil cap and the 50 ohm output line.

Pin 10 mw.

Pout 100-125 mw.

* Icq adjusted with this resistor for 70-80 ma.

(215) 355-5400

MARKETLINE™
SYSTEMS, INC.
975 JAYMOR ROAD
SOUTHAMPTON, PA. 18966

Computers & Peripherals

KC7ZK

CARL BARISH

PRINTECH 13620 NE 20th Suite D
PRINTING Box 4247
Bellevue, WA 98009
746-6000

NE 7-6329

GEORGE S. VAN DYKE, JR., P.E.
CONSULTING ENGINEER

W3HK

4807 CONVENT LANE
PHILA., PA. 19114



AMIL S. CUMULA
PRESIDENT

A. G. RADIO PARTS CO.
939 TOWNSHIP LINE RD.
ELKINS PARK, PENNA. 19117
TELEPHONE: 215-886-9100

RCA Authorized
Distributor

(302) 328-7728
ORDER LINE 800-441-7008



Delaware Amateur Supply
"AMATEUR SALES AND SERVICE"

PAUL WA3QPX
KATHY KA3LYO

71 MEADOW ROAD
NEW CASTLE, DELAWARE 19720

AMATEUR
SALES & SERVICE

(215) OL 9-5900

"HAM" BUERGER INC.
Communication Specialists

BOB HERSHMAN
WA3ZID

68 N. YORK RD.
WILLOW GROVE, PA. 19090

P E N N A R C
A GENERAL PURPOSE CLUB

Monthly meetings the 4th Tuesday-8PM
Montgomery County Community College
340 DeKalb Pike, BlueBell, Pa.

CLUB REPEATER - 223.04/224.64 Mhz

The Ham Radio Publishing Group

hr Greenville, NH 03048 (603) 878-1441

HAM RADIO - the Technical Ham's
Magazine. Ask for a free sample
copy or our Book Catalog.

CALL DOC CUTLER (K3CAS)
FOR YOUR ELECTRONIC NEEDS

NEW, RECONDITIONED, OR AS IS.

LOW PRICES

by appointment 215-635-1078

Heathkit®
ELECTRONIC CENTER

Stan Demski
Manager

Heathkit Electronic Center
6318 Roosevelt Blvd.
Philadelphia, Pennsylvania 19149
(215) 268-0180

Veritechnology
ELECTRONICS CORPORATION



**NESHAMINY
TRAVEL
SERVICE**

Harriet Soltoff
Home: (215) 947-4483

Phone:
(215) 757-1585

2337 Neshaminy Blvd.
Bensalem, PA 19020

BROWSING-THURS. 7^{PM}-9^{PM}
SAT. 9^{AM}-4^{PM}

Day-Nite (215) 455-2121

FERTIK'S ELECTRONICS

Components & Equipment

LEON FERTIK

5400 ELLA STREET
PHILADELPHIA, PA. 19120

LUNAR KLM ASTRON
MICROWAVE MODULES
TAMA

(717) 868-6565

THE
VHF SHOP

BOX 349 R.D. 4
MOUNTAINTOP, PA. 18707

K3MKZ
GERRY

215-PI5-9007

WA3POF

RALPH ALEXANDER

Electronic Equipment Repair
Technical Writing

(302) 328-7728
ORDER LINE 800-441-7008



Delaware Amateur Supply
"AMATEUR SALES AND SERVICE"

ROB WA3QIS
GAIL KA3ITN

71 MEADOW ROAD
NEW CASTLE, DELAWARE 19720

215-342-5982

WA3HIT

Paul and Betty Rilling

INCOME DIVERSIFICATION

5830 Weymouth Street -Phila., Pa.19120

73 Amateur Radio's
Technical Journal
PO BOX 931
FARMINGDALE, NY 11737

\$25 one year \$53 three years

215-742-2437

WA3HIT-co-worker

STOTT WINDOW CLEANING
and
BUILDING MAINTAINANCE

We clean and repair windows. We
repair the A.P.Orleans aluminum rods
5723 Rising Sun Ave. Phila. Pa 19120.

"HAM" BUEGER, INC.
 Electronic Equipment Distributor
 "Right in the middle of a lot of good company!"

88 N. YORK ROAD
 WILLOW GROVE, PA 19090
 215-659-5900
 Service Since 1956

If we're
 judged by the
 company we
 keep, we should
 do pretty well!

Xcelite

Wilson Electronics Corp.

APR 28 1984
 PHILADELPHIA
 SPRINGFIELD

TELETYPE
 B BOOKS
 TEN-TEC
 VIBROPLEX
 BRONCO
 "W2AU"
 HAM-KEY
 Loren Antennas
 + hy gain
 ASIATIC
 MIDOR
 DRAKE
 SAKTON
 ICOM
 CHS
 ROHN
 NEQ
 TRW
 TEN-TEC
 B BOOKS
 CUSHCROFT
 KEGONS
 SWAN
 AMSCO
 HUSTLER
 Vector
 MISCOT
 BIRD
 WILSON
 WELDER
 TPL
 GILFER
 LMB
 WISDOM
 M. WELLS
 communications specialty
 MISCOT
 HUSTLER
 Vector
 MISCOT
 BIRD
 WILSON
 WELDER
 TPL
 GILFER
 LMB
 WISDOM
 M. WELLS
 communications specialty
 MISCOT
 HUSTLER
 Vector
 MISCOT
 BIRD
 WILSON
 WELDER
 TPL
 GILFER
 LMB
 WISDOM
 M. WELLS
 communications specialty

Cheese Bits
 2087 Parkdale Ave.
 Glenside, Pa. 19038

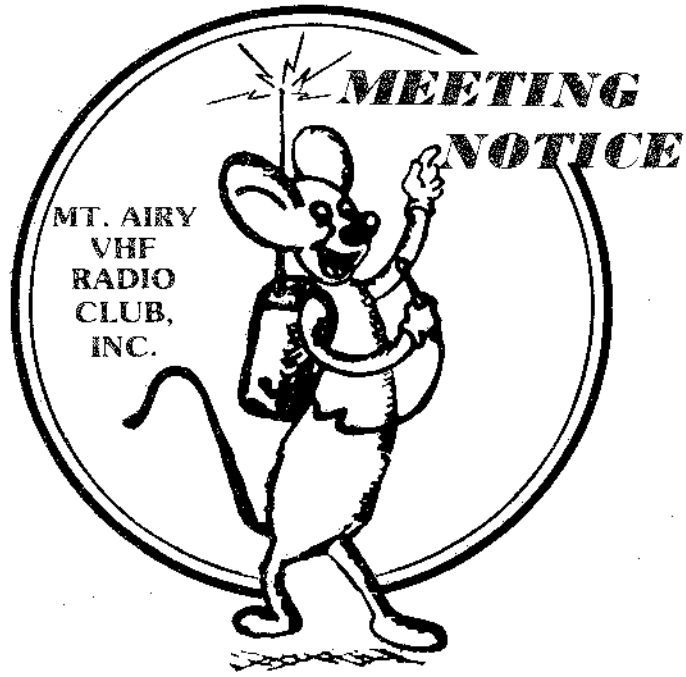
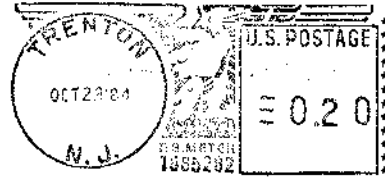

W3FQD
 DICK HUNTZINGER
 130 FAIRHILL DR.
 CHURCHVILLE, PA. 18966

PACK RATS

FIRST CLASS