

# PACK RATS'



# CHEESE BITS



CLUB CALL: W3CCX

MT. AIRY VHF RADIO CLUB, INC.

MT. AIRY VHF RADIO CLUB, INC., PHILADELPHIA, PENNSYLVANIA  
50.125, 144.150, 220.125, 432.110, 1296.110 Mhz W3CCX - Repeater 222.98/224.58 Mhz  
Affiliated Club: AMERICAN RADIO RELAY LEAGUE  
Meetings: Third Thursday of each month at 8:00 P.M.  
Southampton Free Library, 947 E. Street Road  
Southampton, Pennsylvania 19866

ARNS

VOLUME XXVI

NOVEMBER, 1986

NUMBER 11

## THE PREZ SEZ

Our big time of the year for the Pack Rats is over, and I think we had one of the best weekends ever. From all the reports that I have heard said, that the Hamarama was the best that we ever had. People really seem to be getting the idea of more than one to a carload!

We had a good program at the library in October. Ivars, KC2PX gave us an excellent showing of what was available on the commercial market today. Things have changed! No more mosfet mixers and high gain front ends. Good designs with excellent construction are available today. We thank Ivars for coming down and giving us a close look inside some of the boxes.

I would also like to thank Bob, N2SB, for running the board meeting in October.

I am sure as it gets colder, we will be making the final touches to our towers and antennas for the contest in January. Only a few more months to go for another big weekend for the club. We will be hearing more from Bob, N2SB, in the future about the January Contest. That's all for now. Hope everybody is keeping ahead of the leaves in the yard. I will see everybody at the Board meeting in November.

73,

Gary Hitchner, WA2OMY

\* \* \*

Pack Rats XHEESE BITS is a publication of  
THE MT. AIRY VHF RADIO CLUB, INC.  
Philadelphia, Pa. and is published monthly.

SUBSCRIPTION RATE - \$3.00 PER YEAR

We operate on an exchange basis with other  
publications. Anything that is printed in  
CHEESE BITS may be reprinted, unless other-  
wise stated, provided that proper credit  
is given.

SWAP SHOP ITEMS - NO CHARGE

DEADLINE FOR ARTICLES IS THE GENERAL  
MEMBERSHIP MEETING: THE THIRD THURSDAY  
OF THE MONTH.

EDITOR:

W3CL, HARRY B. STEIN  
2087 Parkdale Avenue  
Glenside, Pa. 19038  
215-887-5052

PUBLISHER/SUBSCRIPTION MANAGER:

K3GAS, DOC CUTLER  
7815 New Second Street  
Elkins Park, Pa. 19117  
215-635-1078

PRINTER:

WB2VLA, DAVID POWER  
609-882-1040

TYPIST:

WA3TEM, MARSHA LISSAUER

TRUSTEE OF THE CLUB CALL - W3CCX:

WA3AXV, RONALD WHITSEL  
215-355-5730

AWARDS CHAIRMAN:

W2EIF, JOSEPH KILGORE  
609-783-9478

CLUB HISTORIAN:

W3CL, HARRY B. STEIN

MONDAY NIGHT NETS

7:30 PM - 50.125 MHZ  
8:00 PM - 144.150 MHZ  
8:30 PM - 222.98/224.58 MHZ  
8:45 PM - 220.125 MHZ  
9:00 PM - 432.110 MHZ  
9:30 PM - 1296.1 MHZ

NET CONTROL

W3CL  
W2EIF  
K3GAS  
KS2T  
K3IUU/K1PXE

PACK RAT REPEATER 222.98/224.58 MHZ/ W3CCX  
LOCATED IN CHURCHVILLE, PA.

OFFICERS: 1986-1987

PRESIDENT: WA2OMY, GARY HITCHNER  
VICE-PRES: N2SB, BOB COOK  
COR. SECY : W3CXU, JOHN ALLEN  
REC. SECY : WA3AQA, WALT ZUMBACH  
TREASURER: K3GAS, DOC CUTLER  
DIRECTORS: WB2RVX, MIKE GULLO (EX-OFF)  
WB3DNI, PAT CAWTHORNE (2 Yrs)  
WB2VLA, DAVID POWER (2 Yrs)  
N3CX, DAVE HACKFORD (1 Yr)  
WA3JUF, DAVE MASCARO (1 Yr)



THE AMERICAN RADIO RELAY LEAGUE

**QST**

HUGH A. TURNBULL, W3ABC

Director, Atlantic Division

6800 WOOD ISLAND AVE  
COLLEGE PARK, MD. 20740

(301) 927-1797

1-800-478-2757

AMATEUR  
and  
ADVANCED  
COMMUNICATIONS

"Gisele"  
K3WAJ

G. B. WALLS

3208 CONCORD PIKE (RT. 202)  
WILMINGTON, DEL. 19803



Pennsylvania Institute  
of Technology  
ENGINEERING

PAUL D. MERCADO

Chairperson, Drafting Design Department

215-565-7900

Rosa Valley-Notre Dame Campus  
800 Manchester Ave., Media, Pa. 19063-4088

FOR SERVICE CALL  
(215) 672-3850  
(215) 822-0808



MICHAEL McMACKIN

REGISTERED PLUMBING & HEATING  
BATHROOM INSTALLATIONS • ELECTRIC DRAIN CLEANING

1307 HILLTOWN PIKE  
LINE LEXINGTON, PA 16932

2405 PARKSIDE AVE.  
HATBORO, PA 19040

CALENDAR OF COMING EVENTS

By Harry Brown, W3IIT

NOVEMBER

- 1-2 ARRL November Sweepstakes. C.W. See October QST, Page 90 for the rules. I wonder why they allow sections to be used as multipliers on the HF band contests?
- 2 First Radio Station.
- 2 RF Hill Hamfest at the National Guard Armory, PA. Rte. 152. Sellersville, Pa. Talk-In on 144.71/145.31, 146.28/146.88 and 146.52. For more info call: (215) 257-2450.
- 2 Predicted peak of the Taurids Meteor Shower at 1520 UTC.
- 3 Predicted peak of the Casseopids Meteor Shower at 1515 UTC.
- 3 Old Timers Night by the Philmont Radio Club at the Franklin Institute, Phila., Pa. Meeting at 8:00 P.M.
- 4 EME Perigee
- 4 Election Day
- 11 Veterans' Day
- 13 Pack Rat Board of Directors Meeting at the QTH of K3GAS. All interested parties welcome. Call: 215-635-1078 for directions.
- 15-16 ARRL November Sweepstakes.
- 16 Massilon ARC Auctionfest 86, K of C Hall, 988 Cherry Road, Massilon, Ohio
- 16 West Orange Repeater Club Hamfest at the Orange Elks, 475 Main Street, Orange, N.J. Talk-in on 224.80 and 146.550. For more info call: 201-674-0507.
- 17 Predicted peak of the Leonids Meteor Shower at 0850 UTC.
- 20 November Pack Rat Meeting at the Southampton Free Library on Street Road in Southampton, Pa. All interested VHF'ers are welcome. Meeting starts promptly at 8 PM. 10th Anniversary 432 MHZ EME DXpedition to Colombia, South America. El, K3JJZ will have the slide show. Would be nice to have all the Pack-Rat participants present.
- 22 President John F. Kennedy assassinated in 1963. Where were you?
- 22-23 ARRL EME Contest. Second Weekend. See Sept. QST Pg. 100 for rules.
- 23 Philadelphia Independence Marathon. Look for Charlie, N3MW and maybe W3IIT.
- 27 Thanksgiving Day
- 30 Mark Twain's Birthday

DATES TO REMEMBER

January VHF SS date January 10-11, 1987

Banquet and Ladies Nite May 30, 1987

Holiday greetings for a buck at the November meeting.

New Club Directory is being prepared. Please submit changes to W3CL as soon as possible.

## VHF CONFERENCE REPORT

The VHF Conference this year was a great success for the club. We had over 110 in attendance, which was a few less than last year. However, the holiday probability prevented a few from attending. Plenty of questions were asked of the speakers and anybody who missed it passed up a chance to gain a lot of technical information.

I wish to thank Will, K3PHY, for running the hospitality suite both Friday and Saturday nights. Dave Zimmerman was also helpful with ticket sales and solving the unique problems we normally have. Dave Hackford and Dave Mascaro both did a fine job with a 902 presentation. The attendance for the dinner buffet seemed a little light, but again the holiday had an effect. After dinner, Ron, WA3AXV, presented the slides from the last 3 years at Spruce Knob.

Next year, we will be moving the date for the Conference and the Hamarama. I think we have our work cut out for us, making sure that everybody knows of the change so that attendance does not suffer. See everybody next year!

Gary Hitchner,  
Chairman 1986

\* \* \*

Pack Rats Cheese Bits  
Mount Airy VHF Radio Club  
2087 Parkdale Avenue  
Glenside, Pa. 19038

Dear Harry:

"From Beverages Thru OSCAR-A Bibliography" in "Cheese Bits". It was very well done and I am ready to respond to any requests for either book.

In the meantime, I have transferred all of volume 1 data (over 3 MBytes) onto IBM PC formatted 5.25 inch diskettes and will soon have them available.

In addition, I am considering and have already looked into the possibility of providing these and all future bibliographies on microfiche at a somewhat lower cost. I could have both volumes 1 and 2 on microfiche in less than 1 week.

Finally, given the widespread availability of microcomputers, I will very seriously consider making the bibliography available on other machines; for example the Commodore 64, 128 and Apple II series. Contact: Rich Rosen, 626 Hurricane Hill Road, Mason, NH 03048

\* \* \*

### VISITORS-OCT. 16, 1986 MEETING

KC2PX - Ivars, Belle Mead, N.J.  
WB3KRW - Steve, Doylestown, Pa.  
W3AJS - Ed, Oreland, Pa.

### APPLICATION FOR MEMBERSHIP

WB3KRW - Stephan Dallas  
Box 289, Colonial Park  
Doylestown, Pa. 18901  
215-348-2408

\* \* \*

### TID BITS

Sunspot No. for September 1986 = 3.9 -- Smoothed No. for March 1986 = 13.1.

WA3FOF, Ralph Alexander, back on the air after a six year absence. Good signals on 2, 6 and 220.

Congrats to the Tate Family (K3KTY). Their oldest son, John will be married on November 8, 1986.

New membership directory in preparation. If there are changes, please contact W3CL.

W2CRF, Northwest of Albany, NY (FN32) now on the low end of 220 Mhz on SSB. Handle is Doug.

Circle your calendar. January 10-11, 1987 - The ARRL January VHF SS. May 30, 1987 -

The Pack Rats Banquet and Ladies Nite-Warrington Motor Lodge.

(CONTINUED ON PAGE 5)

SWAP SHOP

FOR SALE: 2 meter Hi-Gain model 2151B antenna. 15 elements, 28 ft. boom (boom comes apart in 2 sections for easy transport. 1718 DB gain) Good condition. Reasonable offer.

CONTACT: W2AXU, Jack Power  
Phone: 609-882-8811

FOR SALE: Icom IC 551-D, 80 watt, 6 meter rig with FM. Used only once, Mint. \$600.

CONTACT: KA3B, Harry Schools  
Phone: 215-468-1866

COMMERCIAL AD

FOR SALE: Collins: 75A2 rcvr w/mechanical filters \$250. Drake: T4XC Xmtr w/ AC4 P/S \$285. "C Line" T4XC, AC4, R4C, MS4 \$450. DSR-2-Lab type gen cov. rcvr \$1200. MN-2000 2KW ant. tuner \$200. ACA P/S \$75. Aux 7 for TR7 \$35. TR4CW, AC4 (mint) w/rit \$395. Icom: IC-751 xcvr loaded \$900. Kenwood: TS520s w/CW filter \$425. R-2000 gen.cov. rcvr \$400. KDK: 2030 FM xcvr \$200.

CONTACT: Tony Musero, K3UKW  
Phone: 215-271-8898

COMMERCIAL AD

Loop Yagis: 902 Mhz and 1296 Mhz 45 ele. \$70. 2304 Mhz \$62.50; Also available assembled and tested. Power dividers, stacking frames available. Linear amplifiers; 1296 Mhz. 1 watt in 18 watts out \$230; 2304: 1 watt in, 10 watts out \$300. Write for more information: Down East Microwave, Bill Olson, W3HQT, Box 1655A, RFD 1, Burnham, ME 04922 Phone: (207) 948-3741.

\* \* \*

A NEW PRODUCT BY Tony

50 WATTS LINEAR AMPLIFIER 420-470-MHz, FM-SSB-ATV KIT NO. 1. Now you can build your very own linear amplifier that works on UHF band of 420 to 470 Mhz for under \$50 dollars. This kit (#1) is designed to work with 8 to 10 watts of input and amplifies it to 40 to 50 watts of output. Kit (#2) is designed to work with 20 to 35 watts of input and amplifies it to 100 to 150 watts of output. And, kit (#3) is designed to work with 8 to 10 watts of input and amplifies it to 100 to 150 watts of output. All kits come with all the necessary parts (except heatsink/ use your own) and detailed photos with complete instructions and illustrative diagrams for trouble-free assembly and usage. All kits are designed to work in FM mode. Cost \$39.95 plus \$3.50 P/H = \$43.45.  
CONTACT: Points South Electronics, 4009 West 18th Avenue, Hialeah, Florida 33012 Phone: (305) 557-9477

\* \* \*

TID BITS CONTINUED

N2SB travelled to FM19 on October 19, 1986 and worked WB2NPE on 903 and 2304. He managed to work N3CX on 903 but not on 2304! WA3NUF didn't make it either. They are going to try again on the 26th.

Received "The IEEE at Drexel Newsletter" and note that our own Paul Drexler, WB3JYO is the Secretary of the 1986 Drexel (Day) IEEE Staff. Keep up the good work, Paul!

\* \* \*

FROM ARRL LETTER OF OCTOBER 13, 1986  
RADIO CLUB OF AMERICA BANQUET

The Radio Club of America will have its annual technical symposium and awards banquet Friday, November 21, at the New York Athletic Club in New York City. Tickets to the event are \$60 each. For more information contact Connie Conte, 145 Main Avenue, Clifton, NJ 07014, at 201-473-8822. Note: Our member W2HK, BB Wentzel, will be honored at this event.

7 Watt Class 'C' Amplifier for 2.3 GHz.

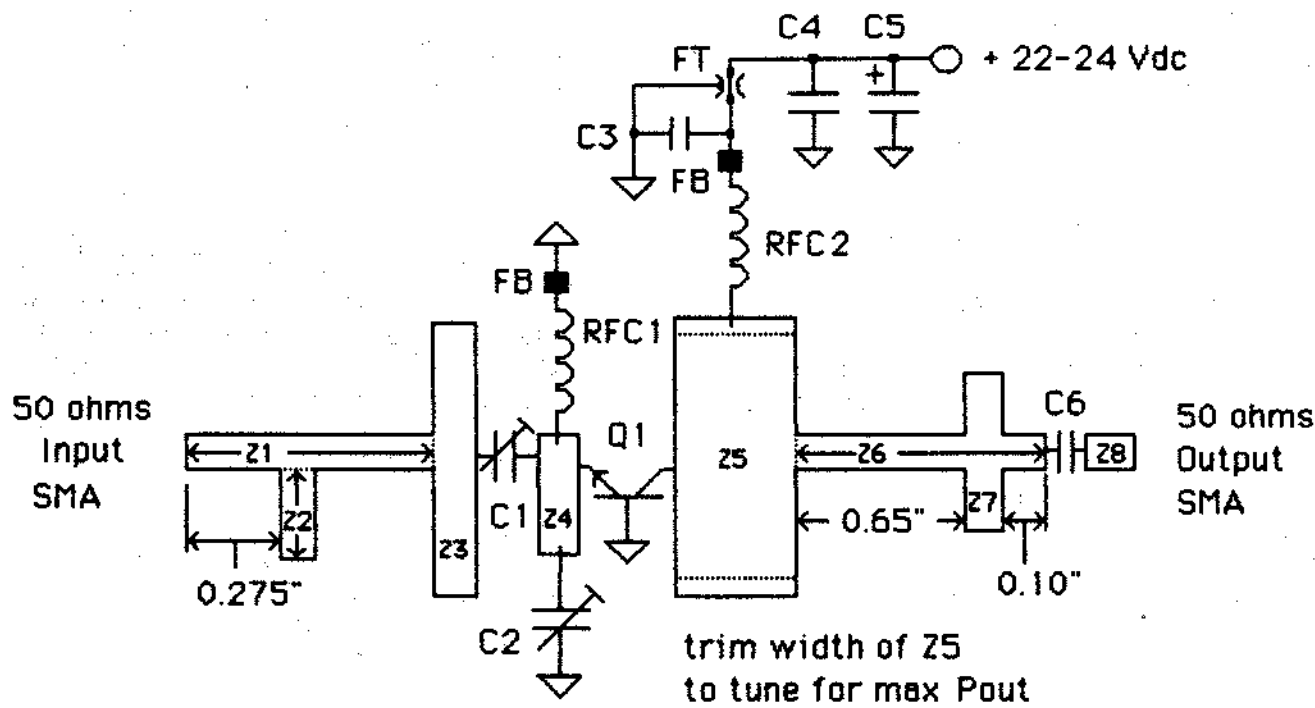

Board material is 1/32" Teflon Er=2.5

Q1 Thomson CSF Semiconductor SD1817 (2307)

RFC1,2 3t, #26, 0.10" ID

C1 3 pf Johanson Gigi-trim cap

C2 0.3 pf - 3 pf Johanson piston trimmer

C3,6 47 pf chip cap

C4 .01 ufd disc

C5 10 ufd/35 Vdc

FB ferrite bead

FT Spectrum Controls, Inc. feedthru

\*SCI 729-303 (or .001 ufd)

Z1 0.08" X 1.1"

Z2 0.15" X 0.38"

Z3 0.07 X 0.85"

Z4 0.11" X 0.3"

Z5 0.4" X 0.8"

Z6 0.1" X 0.88"

Z7 0.15" X 0.7"

Z8 0.08" wide 50 ohm line

Pin 1 Watt

Pout 7 Watts

Pin Set. 2 Watts

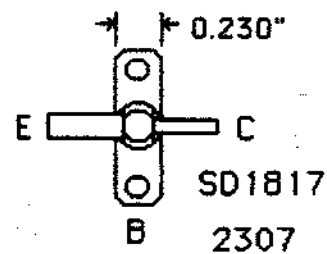

WA3JUF

D. Mascaro 1985

NOV. 1986 CHEESE-BITS

FROM RF NEWS  
MICROWAVE UPDATE 1986 SHOWS AMATEUR  
RADIO CONTRIBUTIONS

Technical seminars on amateur radio communications at microwave frequencies drew dozens of participants to Estes Park, Colo., on Labor Day weekend to exchange ideas on the design and construction of equipment for the L-,S-,C-,X- and K- bands. Don Hilliard, a National Bureau of Standards researcher, was the organizer of the conference. Although an "amateur" group, over half of the attendees were RF professionals employed by such firms as Texas Instruments, Martin Marietta, Westinghouse, Michigan Tech and San Jose State.

Topics presented included design techniques for low-cost MMIC amplifiers, a discussion of spectrally pure crystal oscillators, construction of a tetrode cavity amplifier for 1.3 GHz, and an interesting report on experiments with rainscatter propagation at 5.76 GHz. Other papers emphasized practical aspects of performance measurement, construction and modification of equipment. A description of the S-Band transponder included in the next amateur radio satellite was another presentation of note.

With recent allocation of new operating frequencies, the microwave spectrum represents the greatest technical challenge to amateur radio enthusiasts. Lack of commercial equipment makes it necessary to build or modify equipment, and the ingenuity of these technically advanced hams in finding low-cost solutions was clearly evident.

Tnx, W3HKZ

\* \* \*

FROM ARRL LETTER OF OCTOBER 13, 1986  
ANOTHER NEW COSMOS ON 2304 MHZ

WB5LUA and W4HHK report reception of a new Cosmos satellite on 2304 MHz beginning October 2. This second satellite almost identically follows by 13 hours an earlier new Russian bird that was reported in the ARRL Letter of September 15. The first satellite is being received for five hours beginning at sunrise. The second is heard in the evening with a maximum elevation of 16 degrees at the end of a pass. For more information contact Paul Wilson, W4HHK, P.O. Box 73, Collierville, TN 38017.

\* \* \*

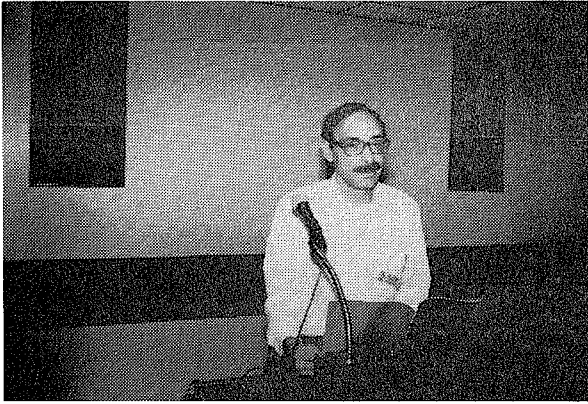

WA2FXB - SID LIEBERMAN

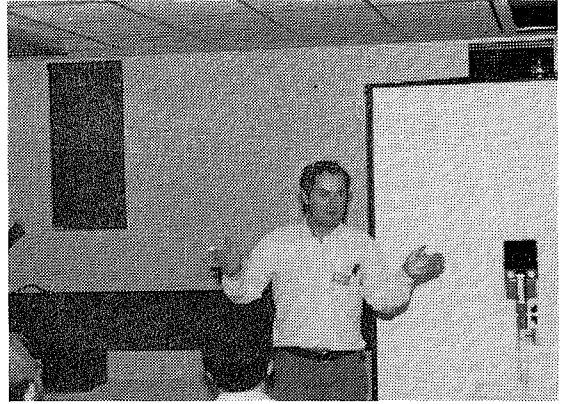

WA2AAU - DICK FREY

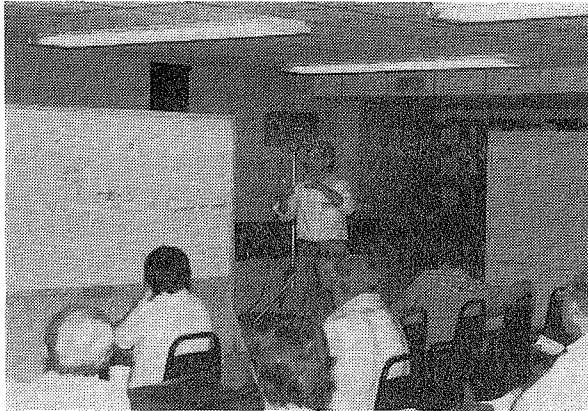

W9IP - MIKE OWEN

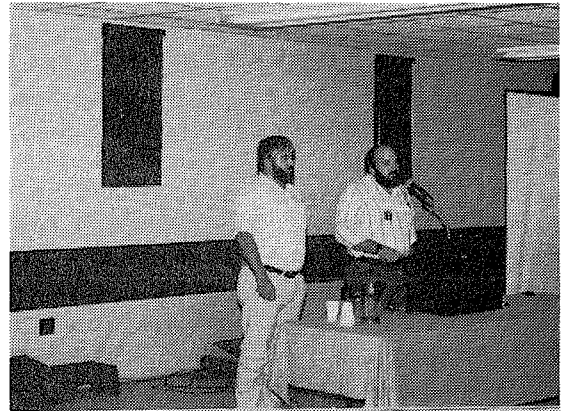

WA3JUF - DAVE MASCARO ... N3CX - DAVE HACKFORD

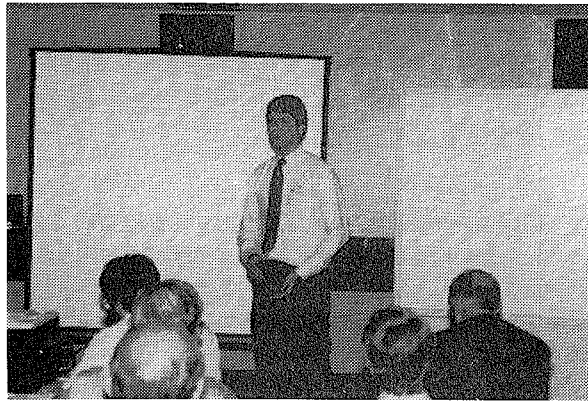

K1FO - STEVE POWLISHEN

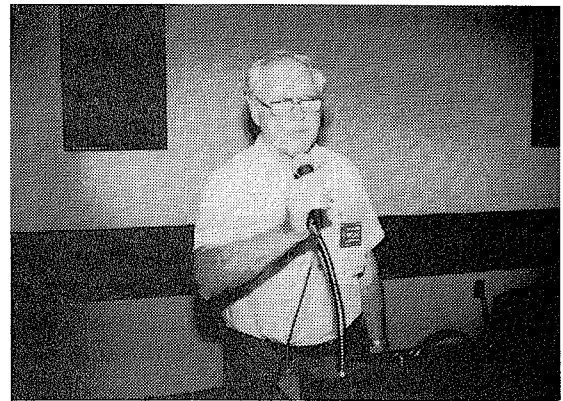

W3XO - BILL TYNAN

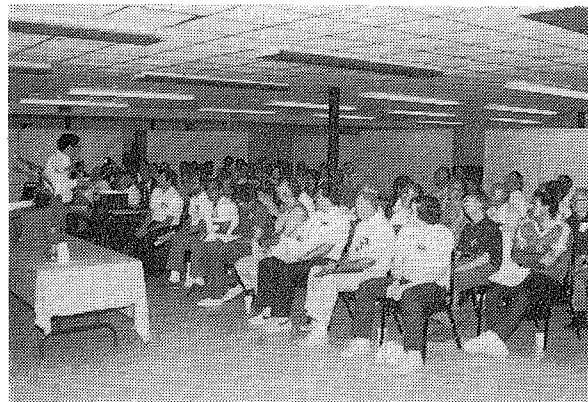

PAYING ATTENTION

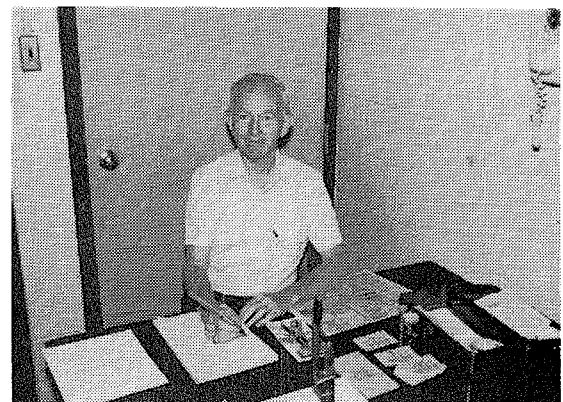

W2KFC - LEE MILES

CONFERENCE '86



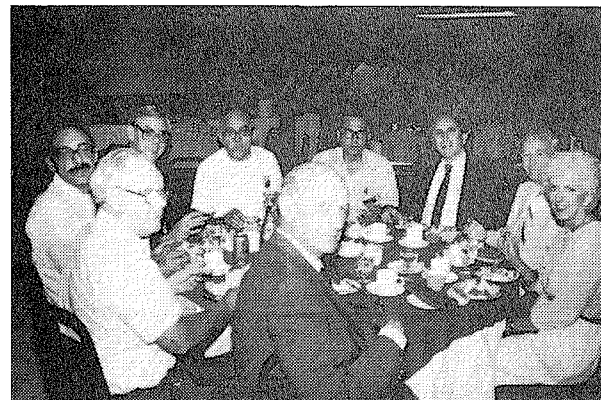
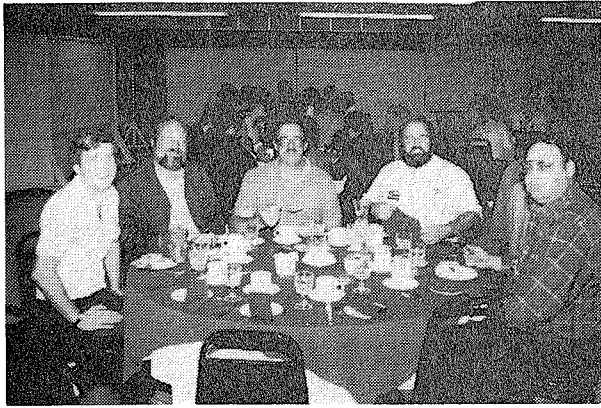

CONFERENCE BANQUET '86

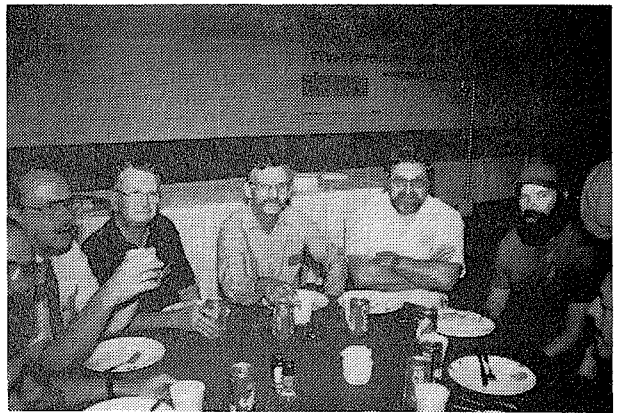
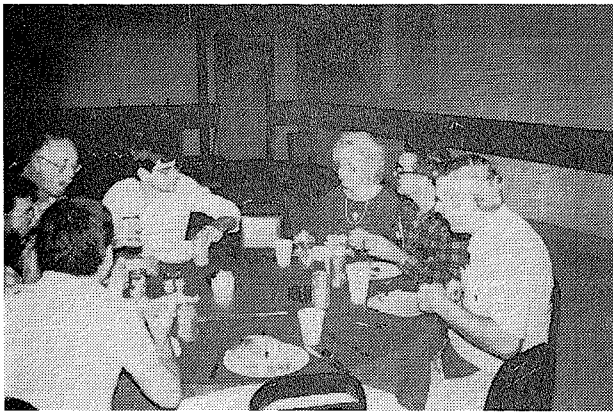

CONFERENCE LUNCHEON GUESTS

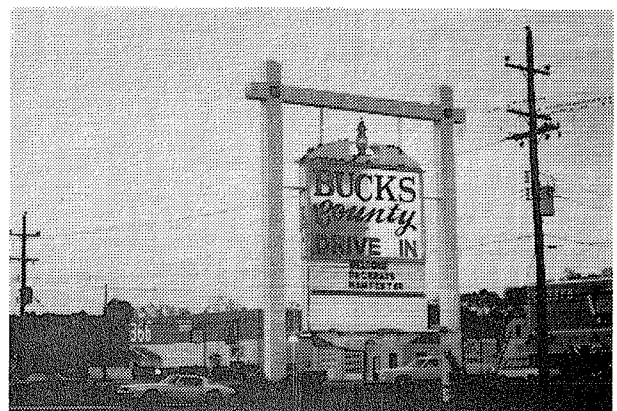
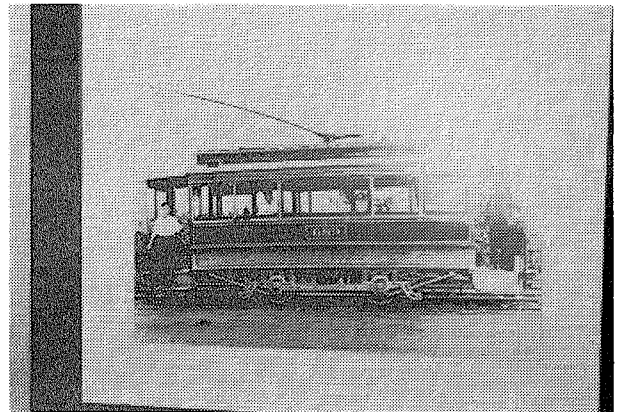

TID BITS

Sunspot No. for August 1986 = 7.4 -- Smoothed No. for February 1986 = 13.2.

Past President, Charley Lustick, K3HSS is back home after a long stay in the Hospital. He is feeling better and moving about.

Congratulations to Rose and Harry Brown (W3IIT) on the recent marriage of their daughter. Our best to the bride and groom.

Hy Ecksel, WA3NDE enthusiastically participated in the Bar Mitzvah of his third grandson. Congrats Hy!!

N3BBI, Mike Pandolfo having TVI problems on 6 meters because of poor cable TV installations in his area. Hope things get resolved real soon, Mike.

Received the following - "greetings from your man on Prince Edward Is. No. 220 up here. Four 2M rpters. Sally is cold and ready to go South for the Winter. Lyn, W3NSI."

Tnx to Paul, WB3JYO on doing a fine job pinch-hitting as recording sec'y at our last Board meeting.

Old friend, Ed Keener, W3AJS, has been vacationing in Bernard, Maine - Rocks overlooking the sea. Sends 73 to the Pack-Rats.

\* \* \*

FROM THE ROCHESTER VHF GROUP JOURNAL

An article in the August issue of InfoWorld (a computer industry newspaper) discusses a proposal by Donald Stoner of the Microperipheral Corp. in Redmond, Washington to take 52-54 Mhz away from the hams. As you may know, he is proposing a public packet radio network using these frequencies. Stoner, a licensed amateur himself, says that since there are 20 states which do not list active repeaters in the 6 meter band, the band is not being used. He further states that hams opt not to use the band "to avoid interference from VHF signals" the article states. Stoner goes on to say that the radio data network would be cheaper to use and support improved transmission compared to the normal phone network. The ARRL has opposed the plan, stating that such a computer network could be assigned a much smaller band of a few kilohertz, but Stoner has replied that all 2 Mhz are needed to avoid crowding.

The FCC is scheduled to issue a preliminary ruling for public comment in November, the main issue being whether or not the band is really under-used.

Can you imagine an area such as Rochester, NY, where channel 2 in Buffalo is a weak signal, suddenly being swamped with 1 Watt (or 100 mW) digital signals at 2 MHz below video carrier? What about the areas that do have 6 meter repeaters? What about the spillover into 50-52 Mhz or channel 2 from those that modify their modems to avoid the crowd, similar to the situation at 27 Mhz? What about all the wierd propagation effects that caused TV channel one to be passed over to the hams in the first place? "Skip" would be a digital person's nightmare, but is the main reason the hams like the band. No other ham bands offer the combination of propagation effects of 6 meters, not too low for aurora and not too high for ionospheric and tropospheric effects. What a waste to allocate this band to a service which avoids these effects.

Here is another example of use it or lose it. Dust off the old 6 meter gear and put it on the air! This is the only band where you'll find CW, SSB, AM and FM in the same place. Sunspots aren't necessary to make this band exciting.

D. Pedtke - KW2T

\* \* \*

**"HAM" BUEGER, INC.**  
 Electronic Equipment Distributor  
 "Right in the middle of a lot of good company!"  
 68 N. YORK ROAD  
 WILLOW GROVE, PA 19090  
 215-659-5900  
 Service Since 1956

If we're judged by the company we keep, we should do pretty well!

CODE OF ETHICS



**Wilson Electronics Corp.**  
**Xcelite**  
**SPRAGUE**  
**TELEX**  
**CUSHCROFT**  
**AMPHENOL**  
**TRW**  
**TEN-TEC**  
**VAROPLEX**  
**BEARCAT**  
**"W2AU"**  
**Larsen Antennas**  
**ASTATIC**  
**ROHN**  
**South River**  
**HAM-KEY**  
**ICOM**  
**Saxton**  
**DRAKE**  
**CDP**  
**Weller**  
**TPL**  
**GILFER**  
**LMB**  
**nte**  
**MIDWEST**  
**Waldom**  
**Melby**  
**communications specialists**  
**MISCO**  
**Vector**  
**HUSTLER**  
**phylas**  
**AMCO**  
**SMAN**  
**COVER CRAFT**  
**AMP SPECIAL INDUSTRIES**  
**ESB**  
**BW**  
**TJR**

**Cheese Bits**

2087 Parkdale Ave.  
 Glenside, Pa. 19038

**MEETING NOTICE**



MT. AIRY  
 VHF  
 RADIO  
 CLUB,  
 INC.

**PACK RATS**

FIRST CLASS