

PACK RATS'



CHEESE BITS



CLUB CALL: W3CCX

MT. AIRY VHF RADIO CLUB, INC.

MT. AIRY VHF RADIO CLUB., "THE PACK RATS", PHILADELPHIA, PA.

NET FREQUENCIES: 50.150, 144.150, 222.125, 224.58/222.98, 432.110, 903.100, 1296.100 MHz

AFFILIATED CLUB: AMERICAN RADIO RELAY LEAGUE

W3CCX

ARNS

Meetings: Third Thursday of each month at 8:00 PM

Southampton Free Library, 947 E. Street Road

Southampton, Pennsylvania 18966

SCANNED TO PDF BY BERT, K3IUV, 2013

VOLUME XXXV

September 1993

NUMBER 9

THE PREZ SEZ

It's history now, but if you missed this year's club picnic, you missed perhaps the best-ever picnic at Dave N3CX's. There was something for everyone from casual eyeball QSO's to a refreshing dip in the pool to rigorous athletic competitions. Many thanks to Dave and Sylvia for another FB club picnic!

The next big event on the Packrat calendar is HAMARAMA '93. This year we'll be back in the Bucks County area, so it should be more convenient for members to attend this important club function. On Saturday, October 2nd we'll hold our VHF conference at the Days Inn on Rt. 611, just north of the PA turnpike. Chairman John, KB3XG has a terrific line-up of speakers planned covering a variety of topics of interest to the weak signal VHF'er. I'm told the prize contributions for this year's banquet will be bigger than ever! On Sunday our fleamarket will be returning to the Bucks County Drive In on Rt 611 in Warrington. Word has it that vendors and buyers both are happy to be back at this location.

It's important that every Packrat participate in these events. The conference on Saturday provides a unique opportunity to learn what other hams are doing in the VHF/UHF/microwave weak signal area and to place a face with the call signs you've worked on the bands. Those of us who recently went to the Eastern VHF conference can tell you how much this can recharge your VHF batteries! The fleamarket on Sunday enables the club to stay afloat financially. Please talk to WA2OMY, WB2YEH, KB3IB or myself if you have not yet volunteered.

Our September meeting will be back at the Southampton library and will feature a slide presentation by Tony, W3HMU recounting the 1976 Packrat Dxpedition to activate Columbia, HK1TL on EME.

See you in the September VHF QSO party.

73

Paul Drexler, WB3JYO

-September 1993 Cheesebits Pg. 1-

Pack Rats CHEESE BITS is a publication of the Mt. AIRY VHF RADIO CLUB, INC. Philadelphia, PA. and is published monthly.

SUBSCRIPTION RATE: \$10.00 PER YEAR (USA)
 \$12.00 PER YEAR (CANADA)
 \$15.00 PER YEAR (ELSEWHERE)

We operate on an exchange basis with other publications. Anything that is printed in CHEESE BITS may be reprinted, unless otherwise stated, provided proper credit is given.

DEADLINE FOR ARTICLES AND SWAP SHOP IS THE MONTHLY MEETING DATE. NON-COMMERCIAL SWAP SHOP ITEMS-FREE OF CHARGE.

SUBSCRIPTION/ADVERTISING MANAGER:

Bob Fischer, WB2YEH
 7258 Walnut Avenue
 Pennsauken, NJ 08110
 (609) 665-8488

EDITOR:

Harry Brown, W3IIT
 3012 Potshop Road
 Norristown, PA 19403
 (215) 584-4846

CLUB TREASURER:

Dave Mascaro, WA3JUF
 1603 Mink Road
 Ottsville, PA 18492
 (215) 795-2648

AWARDS CHAIRMAN:

Joe Kilgore, W2EIF
 (609) 783-9478

TRUSTEE OF CLUB CALL - W3CCX

Ron Whitsel, WA3AXV
 (215) 355-5730

PACKRAT 222 MHz REPEATER - W3CCX/RPTR

222.98/224.58 MHz, Churchville, PA

OFFICERS: 1991-1992

PRESIDENT: WB3JYO, Paul Drexler
 VICE-PRES: WB2OMY, Gary Hitchner
 REC. SECR: WA3AQA, Walter Zumbach
 TREASURER: WA3JUF, Dave Mascaro
 COR. SECR: N3AOG, Dick Comly
 DIRECTORS: N3EXA, Brian Taylor (1 YR)
 K3ESJ, Bill Jaxheimer (1 YR)
 WA3AXV, Ron Whitsel (2 YRS)
 WB2YEH, Bob Fisher (2 YRS)

MONDAY NIGHT NETS

TIME	FREQ.	NET CONTROL
7:30 PM	50.150 MHz	K3EOD
8:00 PM	144.150 MHz	W2EIF
8:30 PM	222.125 MHz	WB2YEH
8:30 PM	224.58R MHz	K3ACR
9:00 PM	432.110 MHz	WA3AXV
9:30 PM	1296.100 MHz	WA3NUF
10:00 PM	903.100 MHz	N3AOG

COMMITTEE CHAIRMEN

LADIES' NIGHT: WA3YUE 215-666-1558
 JUNE CONTEST: WB3DNI 215-672-5289
 HAMARAMA: WB3JYO 609-538-1687
 VHF CONFERENCE: KB3XG 215-270-3158



THE AMERICAN RADIO RELAY LEAGUE

HUGH A. TURNBULL, W3ABC
 Director, Atlantic Division

OST

6903 RHODE ISLAND AVE.
 COLLEGE PARK, MD 20740

(301) 927-1797

1-302-478-2757

**AMATEUR
 and
 ADVANCED
 COMMUNICATIONS**

"Gisele"
 K3WAJ

G. B. WALLS

3208 CONCORD PIKE (RT. 202)
 WILMINGTON, DEL. 19803

Graphic Design

Illustration

Production



Lynne D. Whitsel

209 Frog Hollow Road
 Churchville, PA 18966
 215 355-5730

Calendar of Coming Events -September 1993

- 2 Canada UHF Sprints at 1900 to 2300 local time. Includes 903, 1296 and 2304 MHz. See the September issue of CQ for details. Exchange is call and grid square. Scoring is number of contacts times the number of grid squares. Send logs to Dana Shtun, VE3DSS, 500 Willard Ave., Toronto, Ontario MS6 3R6, Canada,
- 6 Labor Day
- 8 Canada 432 MHz Sprints, 1900 to 2300 local time. See 2 Sept.
- 9 Mt. Airy VHF Radio Club Board of Directors meeting will be held at the QTH of Pat, WB3DNI. Call 215-672-5289 for directions. Directors and all interested parties are welcome.
- 11 Flemington Fallfest at the Warren County Fairgrounds in Harminy, New Jersey. VE Exams. TI on 147.375 and 146.82.
- 12 LIMARC Hamfest will be held at the NY Institute of Technology, Rte 25A in Old Westbury. TI on 146.25/.85
- 12 36th Annual F.A.R. FEST (Gaithersburg Hamfest) will be held at the Montgomery County Agricultural Center (Fairgrounds) in Gaithersburg, MD. TI on 146.955. VE Exams.
- 11-13 September VHF QSO Party. Starts 1800 UTC Sat. and continues thru 0300 UTC Mon. See Aug QST, page 102 for rules. Get on and at least give out a few points. Participation Pins available for everyone making 25 or more contacts.
- 14 Canada 220 MHz Sprints, 1900 to 2300 local time. See 2 Sept.
- 16 First Indoor Meeting of the fall season of the Mt. Airy VHF Radio Club will be held at the Southampton Free Library on Street Road in Southampton, Pa. All members and interested VHFers are invited to meet and share with us. The talk will be by Tony, W3HMU on the famous HK1TL 432 MHz EME DXpedition to Columbia.
- 16 Rosh Hashanan
- 18-19 ARRL 10 GHz Cumulative Contest. See June QST, page 113 for rules.
- 19 SJRA Hamfest at the Pennsauken High School in Pennsauken, N.J. VE Sessions. Talk-in on 144.69/145.29.
- 24-25 Microwave Update will be held at the Northeast Hilton in Atlanta, Ga. For information, contact Jim Davey, W8NLC, Conference Chairman, 4664 Jefferson Township Place, Marietta, Ga. 30066 or call him at 404-333-2136(W) or 404-998-6971(H).
- 25-26 York Hamfest sponsored by the York ARC and Keystone VHF Club and Hilltop Transmitting Society. TI on 146.37/97. VE exams.
- 25 Yom Kippur
- 27 Canada 144 MHz Sprints, 1900 to 2300 local time. See 2 Sept.

contd on pg. 4

Calendar of Coming Events -September 1993 Continued

Oct.

- 2 Canada 50 MHz Sprints, 1900 to 2300 local time. See 2 Sept.
- 2 The 17th Annual Mid Atlantic VHF Conference will be held at the Days Inn Motel, 245 Easton Road, Horsham, PA. 19044. Call the Inn at 215-674-2500 for room reservations. For further info, contact the Conference Chairman, John Sortor, KB3XG, 215-354-1635. See more details elsewhere in this issue of Cheesebits.
- 3 Mt. Airy VHF Radio Club "HAMARAMA" is back at the Bucks County Drive In Theater on Rte 611, 5 miles north of PA Turnpike exit 27 in Warminster, Pa. TI on 146.52 and 223.5. See the flyer elsewhere in Cheesebits.

TID BITS:

New Beacons: VE2FTR has a set of new beacons on in FN08. They are as follows:

<u>Band</u>	<u>Frequency</u>	<u>Power</u>
144	144.280	20 watts
222	222.280	6 watts
432	432.280	30 watts

The NorthEast Weak Signal Group has been formed for those interested in the New England area. Their next meeting will be held at the Quality Inn in Vernon, CT (same place as the Eastern VHF Conference in Aug) on Saturday, 25 Sept. at 1 PM. There will be a talk by N1CI and K1FO on The World's Largest 432 Yagi Array.

New: 6 Meter Beacons: CT0WW on 50.030 and VP2EA on 50.012.

1994 January VHF Sweepstakes

By Phil, WA3NUF

Although the weather is warn and HAMARAMA is still a month ahead, it is time to start planning for the upcoming January VHF Sweepstakes contest. As everyone remembers, the Packrats lost the top spot last year for the first time since the club began to compete in the VHF S/S. Worst of all, our friendly rivals up north in Rochester succeeded in out scoring the Packrats for the first time ever. The ROVER Rule may have helped tip the scale but the effort and organization that Rochester put in made the difference. The line in the sand has been drawn - it's up to the mighty Packrats to reclaim the gavel in 1994.

Don't wait for the leaves to fall to start making your contest plans. To win this year, we need a fresh and early start. Get on the Monday Night nets and check out your equipment. Put out the call for help for any antenna problems you may have. Use the upcoming hamfests to look for parts you need for that new band you plan to be on. And most important , keep your eye out for new prospective members. We need you to help recharge the Packrats this January.

6 METER NET FREQUENCY CHANGE

By: Al, K3EOD

As previously announced, the Monday night net that mmets at 7:30 PM will shift from 50.125 to 50.150 to avoid conflict with users of the "Calling Frequency". See You Monday evenings.

THE RETURN OF THE CRUNCHPROOF 144 MHz TRANSVERTER PROJECT

By: WB3JYO

After a brief rest, the next installment of the 144 MHz project continues. The schematic and parts list for the 28 MHz post amplifier is in this issue. For those that have been observant, it is the same as that used in my 50 MHz transverter series that was in the January 1992 issue of Cheesebits.

SWAP SHOP

Send non commercial swap shop items to the editor.

WANTED: 3 FT. DISH with a F/D of around 0.5 or shallower. Will trade from vast N3CX supply of goodies or \$. Call: Dave, N3CX at 215-679-7293.

WANTED: Manual, schematic or technical data on a Servo Engineering TWTA model 3005-2. Contact: Harry, W3IIT at 215-584-4846. Address on page 2.

FOR SALE: Desk Microphones, Kenwood MC60, \$90.00, Yaesu MD1, \$80.00, and Radio Shack HTX100 10 Meter Transceiver, \$199.99. Call: Bill, W3VIR at 215-357-6549.

FOR SALE: Two (2) Cushcraft 220B 220 MHz Boomer's, \$75.00 ea., 1 Cushcraft 617-6B 6 Meter Boomer, \$160.00, two Andrew 8 Ft. aluminum dishes, 0.37 F/D, \$125.00 ea. Contact Vic, WA3GOO, 717-54803164 evenings.

COMMERCIAL AD

LOOP YAGIS: 902 MHz 33 element \$89 kit, \$109 assembled and tested. 1296 MHz 45 element, \$89 kit, \$109 assembled and tested. 1296 MHz 55 element "Sooper Looper" \$99 kit, \$124 assembled and tested. 2304 MHz 45 element \$75 kit, \$89 assembled and tested. Also available: element and hardware kits for the above. 2 and 4-way power dividers. Discount on complete arrays. Solid State Linear Power Amps, 13 VDC: 1296 - 8W in 35W out \$315, 1W in 20W out \$265, 4W in 70W out \$695. GaAs FET Preamps: 903 MHz .8dB NF \$90, 1296 MHz .8 dB, 2304 MHz 1 dB max NF \$140. SHF SYSTEMS No-tune Transverter kits, w/144 MHz IF now available for 903 through 3456 MHz. Write or call for complete catalog. DOWN EAST MICROWAVE, Bill Olson, W3HQT, Box 2301 RR-1, Troy, Maine. For information and orders telephone (207) 948-3741.

CHEESEBITS SUBSCRIPTIONS

Cheesebits subscriptions are available to everyone interested in activities and information from the VHF thorough the microwave frequencies. Subscriptions are for 1 year of 12 issues. For a subscription, send the following information:

Name: _____ Call: _____

Street Address: _____

Town: _____ State: _____ ZIP: _____

Subscription Rate: \$10.00 per year (USA), \$12.00 (Canada), \$15.00 (Worldwide)

September 93 Send to: SUBSCRIPTION/ADVERTISING MANAGER:

Bob Fischer, WB2YEH
7258 Walnut Avenue
Pennsauken, NJ 08110

28 MHz LOW-DISTORTION POST AMPLIFIER

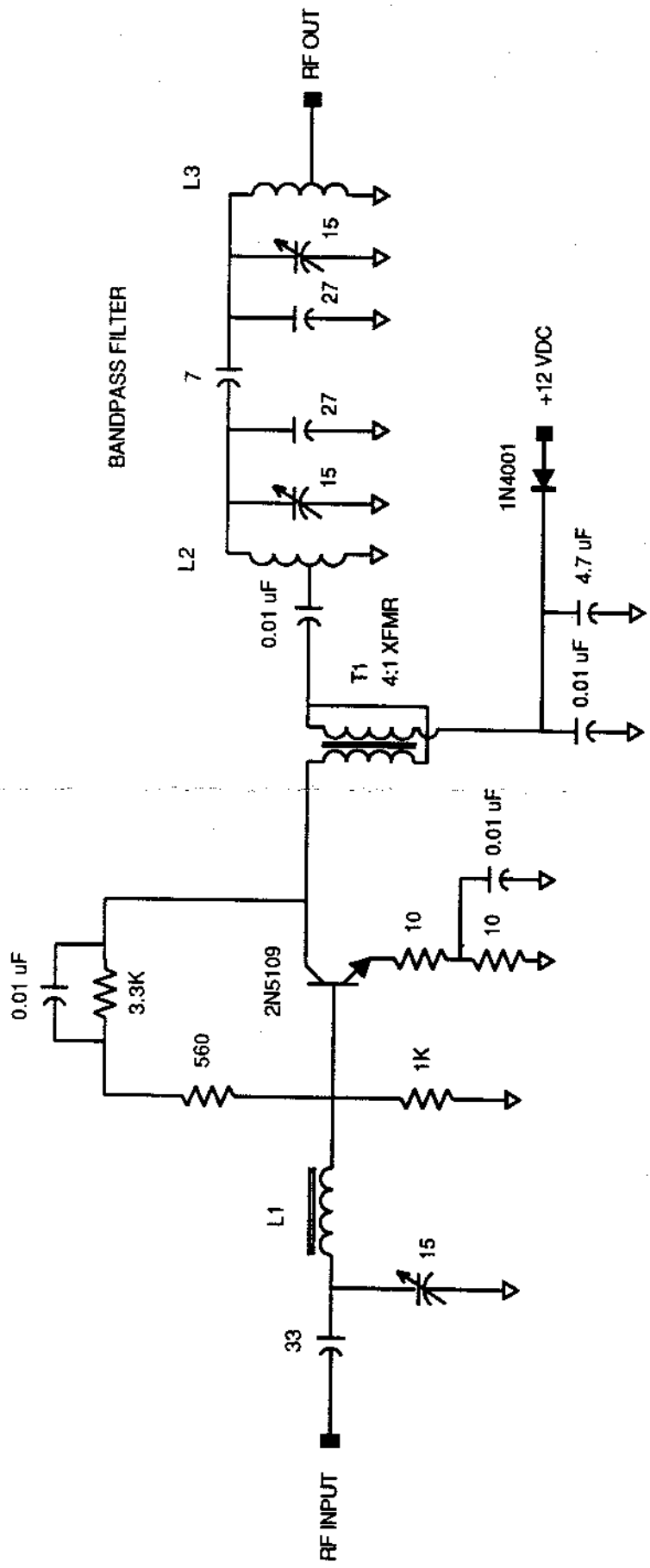

NOTE

- CAPACITANCE IN pF UNLESS NOTED.
- USE PUSH-ON TYPE HEATSINK ON 2N5109
- L1 151 #26 ENAMEL ON T37-6 TOROID
- L2, L3 151 #26 ENAMEL ON T37-6, TAP AT 4:1 FROM GROUND
- T1 201 #30 BIFILAR ON T37-10 TOROID. CONNECT TRANSFORMER AS SHOWN.

2N5109

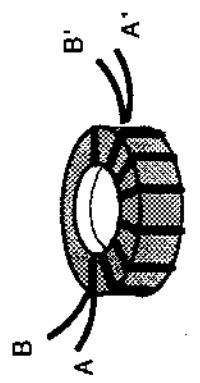
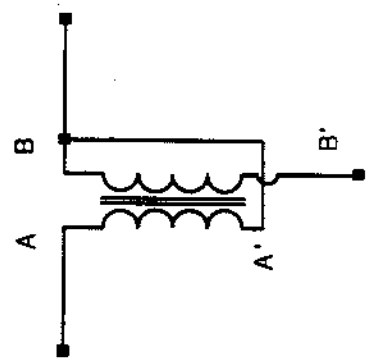
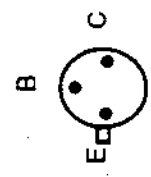

HEATSINK MADE FROM COPPER

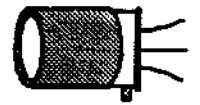

GAIN = 15 dB @ 28 MHz
 Icq = 60 mA
 P1dB = +23dBm
 Third Order Intercept Point = +32 dBm
 STABLE INTO 10:1 VSWR

WB3JYO 12-91

ARRL JULY BOD MEETING - ITEMS FOR VHF'ERS

The ARRL Board of Directors meeting in July resulted in a lot of fine print info reported in the September issue of QST. The following is an extract of some of the items affecting the VHF and above community.

Item 38. Mr. Wyatt, as liaison, presented the report of the Contest Advisory Committee. The CAC is considering, among others, proposals to, to limit same-station rover contacts, The Primary forum for contest issue discussion is the Internet BBS, and for public comment on CAC issues, the packet cluster and the National Contest Journal. The CAC is engaged in the long range planning to anticipate, plan and enhance the ARRL's contest program of the future, looking five and ten years out on technology usage, band impact, categories of participation, recognition programs, scoring and reporting. CAC is also looking at the overall contest program for deletion, addition or modification of specific contacts. (Ed note: It sounds like the CAC members use internet to use Internet and the rest of us have to get on packet and use packet clusters to chat among ourselves or to write letters to NCJ. At the club's ARRL night meeting last May, contest issues were discussed and when asked who at the meeting subscribed to NCJ, only the league people raised their hands. I personally would like to know the mechanics involved in getting viewpoints considered by ARRL Advisory Committees and how the comments get distributed to non CAC members for their comments. The FCC has a mechanism for this but I'm unaware how the CAC does it. Hopefully, it's just my ignorance.)

Item 42. Mr. Rothberg, as liaison, presented the report of the VHF-UHF Advisory Committee (VUAC). The VUAC recommends continuing the role of VUAC in band planning; adopting the SCRREA Proposals, at least on an interim basis, for band plans from 2.3 through 10 GHz; supporting, though it has reservations. The proposals in PR Docket 93-40 for amateur use of 219-220 MHz; and revising the 70-cm band plan to show 426.25 MHz as repeater input with 439.25 MHz as output. The VUAC is opposed to expansion of AVM at cost to the Amateur Radio Service in 902-928 MHz, PR Docket 93-61; favors discouraging the selection of 441 MHz for packet, while encouraging the mode itself; and withholds comment on wind profilers at 449 MHz, because of the lack of technical data on proposed systems.

Item 59. On motion of Mr. Quiat, seconded by Mr. Harrison, the following resolution was adopted:

WHEREAS, the mission of the VUAC and VRAC has changed over time and a need for a new type of committee to address changes brought about by new technology, now therefore

BE IT RESOLVED: A spectrum management committee is created. This committee shall:

1. Restrict it's activities to frequencies above 30 MHz and shall not engage in band planning although it may be tasked with examination and comment on such problem.
2. Examine and consider concerns of amateur operators with regard to mode, digital protocol, frequency utilization, impending technical improvements, applicable governmental regulations and activities, IARU actions and other matters referred to it by the ARRL Board of Directors.

In structure, tenure, mode of communication among members, budget and limitations shall be determined by the Board. Each Director may name up to three League Members to the Committee, one of whom shall speak for the Division. The member's term of office need not be concurrent with the Director's term. A Board Liaison to the Committee shall be designated by the President. A staff liaison shall be designated by the Executive Vice President.

Continued on page 8

3. When band-planning needs are identified, the Committee will recommend to the Board creation of an Ad-Hoc committee to pursue and solve the problem.
4. The contributions of the members of the VUAC and VRAC past and present are recognized and appreciated)

Item 64. On motion of Mr. Mendelsohn, seconded by Mr. Burden, the following resolution was ADOPTED:

WHEREAS, the current and proposed allocation status of the 902-928 MHz band is essentially unplanned, and now includes a large number of users, not all of which are compatible sharing partners, and

WHEREAS, the FCC's recent proposals for additional users of the 902-928 MHz band would result in decreased utility of the band for all users of the band and

WHEREAS, it is essential that certain amateur use of the band including amateur television and weak signal communications, be protected, now therefore

BE IT RESOLVED. that the Executive Vice President, with assistance of staff and the Washington Team seek a primary allocation within the 902-928 MHz band for the Amateur Radio Service.

THE HK1TL MOONBOUNCE DXPEDITION

The September Club meeting will have a presentation by Tony, W3HMU on the Dxpediton that the club made back in 1976. Many new members are unaware of it so here's a brief rundown (Tony will have a lot more stuff). In the 1970's, the club had an active 432 EME station (W3CCX) on the air and all continents had at least one station except for South America. Elliott, K3JJZ had a new ham move into his neighborhood from Columbia, Bolmar, WB3AOP/HK1AMW. Bolmar joined the Packrats and eventually someone came up with the idea of us sending a station to Columbia so that WAS would be possible (W3CCX also needed South America). The club put together a station consisting of 16 K2RIW 432 Yagis fully steerable including polarity rotation. The final amp was a 7650 Linear designed by W3HMU that I believe was written up in ham radio magazine an early FET amplifier. The club worked 16 stations while in Columbia in 8 countries. Al, K2UYH was the first contact and was the first to get WAS on 432 MHz. His picture appeared on the cover of QST a few months later. The Rats that went were Bill, W3HQT, Walt, K3BPP, Tony, W3HMU, Dan, WA3NFV, Bolmar, WB2AOP, and Socrates, WB3AFY. Come out and hear all about it.

HAMARAMA '93

By Paul, WB3JYO

The 1993 Hamarama will be held on Sunday, October 3rd at the Bucks County Drive-In in Warrington, PA. The Drive-In location has become available to us again, bringing the flea market back to the Bucks county area. We will have a greatly expanded club table - bring your labeled hamfest items! It is important that we have 100% club involvement to make this event successful. Please contact one of the individuals below to volunteer your assistance.

<u>Individual</u>	<u>Responsibility</u>
PAUL, WB3JYO	CHAIRMAN
GENE, KB3IB	REGISTRATION/ CLUB TABLE
GARY, WA2OMY	VENDOR PARKING
DICK, N3AOG	BUYER PARKING
BOB, WB2YEH	TICKET SALES



PACK RATS



THE MT. AIRY VHF RADIO CLUB, INC.
PRESENTS

HAMARAMA

SUNDAY, OCTOBER 3rd, 1993
rain or shine

Gates open — Buyers: 7:00 a.m. — Sellers: 6:00 a.m.

BACK BY POPULAR DEMAND:

Rt. 611 DRIVE IN Warrington, PA

Food, beverages & facilities on site — **SORRY, NO OVERNIGHT PARKING**

ADMISSION: \$5.00

SELLERS ADD: \$10.00 per space

TALK-IN: 146.52 (Simplex)

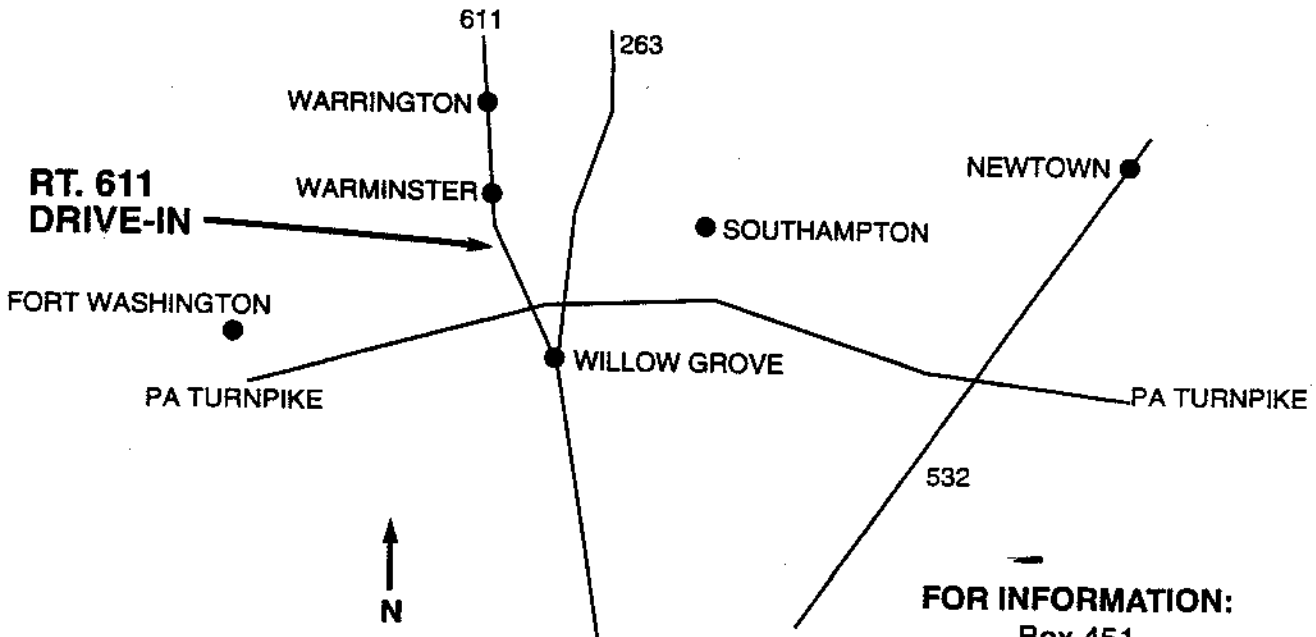

FOR INFORMATION:

Box 451

Montgomeryville, PA 18936

or call K3EOD (215) 742-3312

1993 MID ATLANTIC VHF CONFERENCE

The agenda for the conference is a little more firm now. The initial list of speakers is as follows:

<u>Speaker</u>	<u>Subject</u>
Paul Such, N6TX	How to Win a Nobel Prize
Stan Hilinski, KA1ZE	6 M Point Super Roving
Tom Williams, WA1MBA	Propagation on the 145 GHz Band
Bill Slack, N2XP	Propagation Prediction Software
Dave Holladay, KD5RO(tent.)	Topic to be announced
John Sorter, KB3XG and Paul Drexler, WA3JYO	Push-Pull High Power MOSFet Amps*

* A complete VHF 100 watt amp will be constructed during the 1 hour talk and given away.

The 1993 Mid Atlantic VHF Conference (the 17th annual) will be held on Saturday, October 2, 1993 at the Days Inn motel, 245 Easton Road (Rte 611) in Horsham Pa, just north of Philadelphia, Pa. Horsham is just 3 miles south of our annual hamfest (HAMARAMA '93) being held the next day, Sunday, at the Bucks County Drive-In Theater.

Please make reservations at the Days Inn before September 17 by calling 215-674-2500 or FAXing 215-674-0145. Mention "The Packrats" for special room rates. The cost of food at the conference will be a bit more reasonable this year since there is "Otto's" a German-American restaurant on the other side of the hotel parking lot with a dining room large enough to accommodate everyone. Otto's features meals between \$5.00 and \$10.00 and guaranteed to fill your gut. This will give you more money to spend on VHF and Microwave goodies that you find at the hamfest the next day.

As usual, we will have an outstanding set of speakers with a diverse and challenging talks in the VHF and Microwave areas. If you have any questions or if you or someone you know would like to be considered for giving a talk in one of the open time slots available, write me or give me a call.

73,

John Sorter, KB3XG, Conference Chairman
1993 Mid-Atlantic VHF Conference
PO Box 451
Montgomeryville, PA. 18936
(215) 270-3185

1993 MID-ATLANTIC VHF CONFERENCE REGISTRATION FORM

October 2, 1993

Days Inn, 245 Easton Road (Rte 611), Horsham Pa.

Name: _____ Call: _____
Street Address: _____
Town: _____ State: _____ ZIP: _____

Rate: \$10.00 (includes entry to "Hamarama 93" on 3 Oct.)

Send to: John Sorter, KB3XG, Conference Chairman
1993 Mid-Atlantic VHF Conference
PO Box 451
Montgomeryville, PA. 18936

DOWN EAST MICROWAVE

MICROWAVE ANTENNAS AND COMPONENTS

BILL OLSON
W3HQT

BOX 2310 RRI
TROY, ME 04987
(207) 948-3741

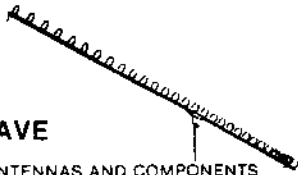

CRAIG HENDERSON
N8DIB

Ph. (419) 352-4465
Mrs. 10-5



C. A. T. S.
Rotor Parts & Repair



7368 S.R. 105

Pemberville, OH 43450

215-288-0325



W3HK

GEORGE S. VanDYKE, JR. P.E.

1737 Scattergood St.
Phila., PA 19124

The R.F. Connection "Specialists in RF Connectors and Coax"

KA3RPG

Joel Knoblock
301/840-5477
Fax 301/869-3680

Order Line 800-783-2666
Suite 11, 213 N. Frederick Ave.
Gaithersburg, MD 20877

(302) 328-7728
ORDER LINE 800-441-7008



Delaware Amateur Supply

"AMATEUR SALES AND SERVICE"

PAUL WA3QPX
KATHY KA3IYO

71 MEADOW ROAD
NEW CASTLE, DELAWARE 19720

(202) 588-1068
(215) 745-6173
(302) 886-7630
(609) 266-3668



COMPU-SIMPLE, INC.

COMPUTER APPLICATIONS FOR SMALL BUSINESS

BRIAN M. WEISMAN
Consultant

P.O. BOX 66374
WASHINGTON, DC 20035

215-342-5982

WA3HIT

Paul and Betty Rilling
INCOME DIVERSIFICATION

5830 Weymouth Street -Phila., Pa.19120

Gerry Rodski - K3MKZ

717-868-5643
6-10 PM

SSB ELECTRONIC U.S.A.
Call for Catalog

124 Cherrywood Dr. Mountaintop, Pa 18707

609-541-0120

Bob Fischer Company, Inc.

AERIAL LADDERS - UTILITY EQUIPMENT

BOB FISCHER
PRES.

28TH & LINCOLN AVE.
CAMDEN, N. J. 08105

DESTINATIONS INC.

A FULL SERVICE TRAVEL AGENCY

HARRIET SOLTOFF
TRAVEL CONSULTANT

616 SOUTH THIRD STREET
PHILADELPHIA, PA. 19147

RES. (215) 947-4483

MOVING - TRAIL 7'x12"
SAT. 8'x4"

Doy-Nite (215) 455-2121

FERTIK'S ELECTRONICS

Components & Equipment

LEON FERTIK

5400 ELLA STREET
PHILADELPHIA, PA. 19120

RICHARD E. COMLY

ARROW

TOOL, DIE & MACHINE CO., INC.
2065 BENNETT RD. PHILA., PA 19116

(215) 676-1300
FAX 934-5237



(609) 268-0736

RICHARD CONNOR



RECON Communications

- COMMUNICATIONS TOWER MAINTENANCE
- ANTENNAS, FEEDLINES, TOWERS INSTALLED
- TOWER PAINTING, RE-LAMPING, RE-GUYING
- RF SYSTEM TROUBLESHOOTING
- LIGHTNING PROTECTION, GROUND SYSTEMS

Emergency Service

412 Carranza Road
Tabernacle, NJ 08068

(302) 328-7728
ORDER LINE 800-441-7008



Delaware Amateur Supply

"AMATEUR SALES AND SERVICE"

ROB WA3QLS
GAIL KA3ITN

71 MEADOW ROAD
NEW CASTLE, DELAWARE 19720

(215) 745-6173
(302) 886-7630
(215) 342-8832
(609) 266-3668



COMPU-SIMPLE, INC.

COMPUTER APPLICATIONS FOR SMALL BUSINESS

ELLIOTT T. WEISMAN
Consultant

P.O. BOX 7161
WILMINGTON, DELAWARE 19803

RUTLAND ARRAYS

For the finest VHF/UHF antennas
1703 WARREN ST.
NEW CUMBERLAND, PA 17070

Call or write for our new catalog!
(717) 774-5298 7 - 10 pm EST

STEVEN N. WHITE

Attorney at Law

WA3IAO

2217 PALOMINO DRIVE
WARRINGTON, PA 18976

TEL: (215) 343-6902
FAX: (215) 343-6903

Wilson Electronics Corp.

Xcelite

Service Since 1956
 417 DAVISVILLE ROAD
 WILLOW GROVE, PA 19090
 215-659-5900

"Right in the middle of a lot of good company!"
 Electronic Equipment Distributor

"HAM" BUEGER, INC.

If we're
 judged by the
 company we
 keep, we should
 do pretty well!

COOL OF EVENING
 WARM
 SWEET

TELEX
 SPRAGUE
 AMPHENOL
 CUSHCOTT
 TAB BOOKS
 TEN-TEC
 TRW
 VIBROPLEX
 BEARCAT
 "W2AU"
 HAM-KEY
 Larsen Antennas
 "high-gain"
 ASIATIC
 ROHN
 NRC
 South River
 MILES
 SAKTON
 ICOM
 GDS
 GDE
 DRANK
 nte
 GILFER
 LMB
 TPL
 Weller
 Waidom
 communications specialists
 MISCO
 RATO
 Vector
 MUSTER
 Johnson
 Dodge
 Linn
 AMECO
 SWAN
 COVER CRAFT
 AMP
 SPECIAL
 INDUSTRIES
 SUMR
 TCR
 3M

Cheese Bits

412 Carranza Rd
 Tabernacle, NJ
 08088



MT. AIRY
 VHF
 RADIO
 CLUB,
 INC.

DICK HUNTZINGER
 W3FQD
 130 FAIRHILL RD.
 CHURCHVILLE, PA 18966

PACK RATS

FIRST CLASS