

# PACK RATS'



# CHEESE BITS



CLUB CALL: W3CCX

MT. AIRY VHF RADIO CLUB, INC.

CQ CONTEST, CQ CONTEST, CQ CONTEST \* GO PACK RATS!! \* CQ CONTEST, CQ CONTEST, CQ CONTEST  
MT. AIRY VHF RADIO CLUB, "THE PACK RATS", PHILADELPHIA, PENNSYLVANIA W3CCX  
NET FREQUENCIES: 50.125, 144.150, 222.125, 224.58/222.98, 432.110, 903.100, 1296.100 MHz  
AFFILIATED CLUB: AMERICAN RADIO RELAY LEAGUE ARNS

Meetings: Third Thursday of each month at 8:00 PM  
Southampton Free Library, 947 E. Street Road  
Southampton, Pennsylvania 19866

SCANNED TO PDF BY BERT, K3IUV, 2013

VOLUME XXXIV

JANUARY 1992

NUMBER 1

\*\*\*\*\*

## THE PREZ SEZ

A HAPPY NEW YEAR TO ALL THE PACK RATS AND THEIR FRIENDS! The year 1992 will be a banner year if all club members pitch in to do what they can for the club. The first order of business is to try to make as many club meetings as possible. As your club president, I am required by the constitution and club bylaws to present certain issues to the general membership for a vote. This will require that 38 or more active club members attend the monthly meetings. We had only 30 members present for the December meeting, so I will introduce these very crucial matters at the January secret contest meeting. Please plan to attend. Your attendance is especially important if you intend to compete on the Pack Rat team during the VHF contest and you've made only one club meeting or less. As our club membership has aged each year, it has been increasingly difficult to gather the required 51 member logs which is required of us by the ARRL to maintain Unlimited Club status. This is the club competition category in which the Pack Rats belong. Each and every member's log is important if we desire to continue the winning ways of the Mt. Airy VHF Club. Individual high scores are not the issue here; this will always be a team effort and everyone can help make 1992 a success. More details will be unveiled at the January meeting. This will be a closed meeting for members only, the only private meeting of the year.

We have appointed N3AOG as our new Health and Welfare coordinator and Dick is interested in hearing from you. Please let him know what's going on with you and your families. Do not assume that the word will get out if you don't call or write to Dick.

To all -- the best wishes for a healthy and profitable New Year. I hope to hear you all on the air working the rare ones.

73, William T. Murphy, W0RSJ

JANUARY MEETING PROGRAM: TRADITIONAL SECRET CONTEST STRATEGY MEETING. SORRY, NO GUESTS ADMITTED... PACK RAT MEMBERS ONLY. COME OUT AND GET PUMPED UP FOR THE BIG EVENT!!

Pack Rats CHEESE BITS is a publication of the Mt. AIRY VHF RADIO CLUB, INC. Philadelphia, Pa. and is published monthly. SUBSCRIPTION RATE - \$10.00 PER YEAR

We operate on an exchange basis with other publications. Anything that is printed in CHEESE BITS may be reprinted, unless otherwise stated, provided proper credit is given.

DEADLINE FOR ARTICLES AND SWAP SHOP IS THE 20TH DAY OF THE MONTH. NON-COMMERCIAL SWAP SHOP ITEMS - FREE OF CHARGE.

SUBSCRIPTION/ADVERTISING MANAGER:

WB2YEH, BOB FISCHER  
7258 WALNUT AVENUE  
PENNSAUKEN, NJ 08110  
(609) 665-8488

EDITOR:

WC2K, RICK CONNOR  
412 CARRANZA ROAD  
TABERNACLE, NJ 08088  
(609) 268-0736

CONTRIBUTING EDITORS:

|                      |                      |
|----------------------|----------------------|
| W3IIT, HARRY BROWN   | WB3JYO, PAUL DREXLER |
| 3012 POTSHOP ROAD    | 24 MAIN BLVD         |
| NORRISTOWN, PA 19403 | TRENTON, NJ 08618    |
| (215) 584-4846       | (609) 538-1687       |

TYPIST/PRODUCTION ASSISTANT:

JANICE CONNOR

AWARDS CHAIRMAN:

W2EIF, JOE KILGORE  
(609) 783-9478

CLUB HISTORIAN:

W3CL, HARRY B. STEIN  
(215) 887-5052

TRUSTEE OF CLUB CALLSIGN - W3CCX

WA3AXV, RON WHITSEL  
(215) 355-5730

PACK RAT 220 FM REPEATER - W3CCX/RPTR

222.98/224.58 MHz, CHURCHVILLE, PA

OFFICERS: 1991 - 1992

PRESIDENT: W0RSJ BILL MURPHY  
VICE-PRES: WB2YEH BOB FISCHER  
REC. SECY: WA3AQA WALT ZUMBACH  
TREASURER: WA3JUF DAVE MASCARO  
COR. SECY: WB3JYO PAUL DREXLER  
DIRECTORS: WA3AXV RON WHITSEL (1 YR)  
K3EOD AL BOBLITT (1 YR)  
N3AOG DICK COMLY (2 YRS)  
WA3NUF PHIL MIGUELEZ (2 YRS)

MONDAY NIGHT NETS

7:30 PM - 50.125  
8:00 PM - 144.150  
8:30 PM - 222.125  
8:30 PM - 224.58/R  
9:00 PM - 432.110  
9:30 PM - 1296.100  
10:00 PM - 903.100

NET CONTROL

W3CL + K3EOD  
W2EIF  
WC2K  
K3ACR  
WA3AXV  
WA3NUF  
N3AOG

VHF CONFERENCE CHAIRMAN:

KB3XG, JOHN SORTOR  
(215) 766-2643

HAMARAMA CHAIRMAN:

K3EOD, AL BOBLITT  
(215) 742-3312



THE AMERICAN RADIO RELAY LEAGUE

OST

HUGH A. TURNBULL, W3ABC

Director, Atlantic Division

6903 RHODE ISLAND AVE.  
COLLEGE PARK, MD 20740

(301) 927-1797

1-802-478-2757

**AMATEUR  
and  
ADVANCED  
COMMUNICATIONS**

"Gisele"

K3WAJ

G. B. WALLS

3208 CONCORD PIKE (RT. 202)  
WILMINGTON, DEL. 19803

Graphic Design Illustration Production



Lynne D. Whitsel

209 Frog Hollow Road  
Churchville, PA 18966  
215 355-5730

## CALENDAR OF COMING EVENTS

By Harry Brown, W3ITT

### JANUARY

- 1 HAPPY NEW YEAR!
- 4 Predicted peak of the Quadrantids meteor shower at 0624 UTC
- 9 Pack Rat board of directors meeting at the QTH of Ernie Kenas, W3KKN. All interested parties welcome. Annual contest "scull session". Meeting starts at 8:00 PM. Call 215-659-3485 for directions.
- 12 AFC and NFC Championship Games.
- 16 Regular meeting of the Mt. Airy VHF Radio Club at the Southampton Free Library on Street Road, Southampton, Pa. Secret contest strategy meeting. Members only - no visitors at this one.
- 18-20 45th Annual ARRL January VHF Sweepstakes. THE CONTEST. See December QST page 99 and your contest packet for details and rules.
- 20 Martin Luther King Jr. Day
- 26 NFL Superbowl XXVI

### JANUARY VHF CONTEST

You should be fired-up and ready to participate in the #1 CLUB SPONSORED EVENT OF THE YEAR for the Mt. Airy VHF Radio Club. If you're not fired-up, maybe you need to attend both the board meeting at Ernie's and the general meeting at the library. If you're not prepared, then possibly you haven't asked for help. Now is the time to take care of any last-minute equipment or antenna problems and needs. Contact your team captain or contest chairman Phil, WA3NUF if you need any help or have any questions. We have crews which are willing to help, even in the final hours.

KB3XG, John and WA3IAC, Chuck will be contest rovers in grid FN10 with equipment for 50 - 3456 MHz. WB3JYO, Paul will be a rover in grid FM28 with bands 144 - 3456 MHz. Look for these guys... they'll be the only game in town on several bands. They will be especially looking for Pack Rats.

Make your best effort to work all Pack Rats on all of your bands. Use the Pack Rat check-off sheet which you received with your packet to aid in this detail. Often we ignore our inherent advantages and wish we had utilized a better strategy. This is the year to make a "clean sweep" of all fellow club members. Non-members should consult the Pack Rat Contest Clock, enclosed in this issue of Cheese Bits, to track down Rat activity during the weekend.

Any member who would like to sign the club callsign W3CCX for the contest weekend should contact Ron, WA3AXV, trustee of the call. That callsign could add extra contact potential to your operation. It's well-known and recognized throughout the country.

Contest log and dupe sheets along with an official ARRL cover sheet should be completed and submitted to either your team captain or the chairman soon after the contest.

"For better it is to dare mighty things, to win glorious triumphs, even though checkered by failure, than to take rank with those poor spirits who neither enjoy much nor suffer much, because they live in the gray twilight that knows not victory or defeat." Give it your best shot, Pack Rats!

VOTED TO MEMBERSHIP

JEFF DEPOLO, WN3A  
420 3. 42nd Street  
Philadelphia, Pa. 19104  
215-386-7199

APPLICATIONS FOR MEMBERSHIP

RONALD CLUCK, N2NVT  
1428 S. Main Street  
Phillipsburg, NJ 08865

JAMES ALEXANDER, N2MVP  
Box 1154  
Bedminster, NJ 07921

TID-BITS

Harry, W3CL has been in and out of Rolling Hills Hospital. Hopefully, he'll be home for the contest which he's very anxious to operate. Cards and letters to Harry's home please.

Ralph, WR3P's mom was in the hospital recently - she's now home and doing well.

Frank, AK30 recently had foot surgery which was successful but involved some recovery complications. Frank's FB now and reported to be doing some pre-contest tower work.

Dave, W3ZD keeps regular schedules from his new Nevada QTH on 21.303 MHz, daily at 1630 EST. He'd like to hear from some ole' Pack Rat buddies. TNX W3KKN.

Thanks to Gary, WA2OMY, and Al, K3EOD for helping W3IIT lower the tower for repairs. Tower was scheduled to be re-installed on January 5.

N3CX provided some help to our FN10 Pack Rat Dave, WB8ZAR. They got his tower and antennas in shape for the contest.

Phil, WA3NUF has a new mast in his tower and his antennas have been re-arranged for optimum performance. Thanks to N3AOG, WB3DNI, WB3JYO, WA3AXV, and W3KKN for their help.

Hal, W3HFY hosted an antenna party and he's now set for the contest. Help was provided by WB3DNI, N3CX, N3AOG, W0RSJ, and W3IIT.

WC2K had a surprise QSO with Lenny, W2GGB recently on one of the SNJ 2-meter repeaters. Lenny has been through some trials with his health over the past few years but has recovered very well and may be getting active on VHF a little more. Much of Lenny's time is consumed by caring for his wife who is hospitalized. He was running an indoor homebrew 2-element quad which he had been experimenting with. Expect to see Lenny at a club meeting in the future and look for W2-Go-Go-Baby on 2-meter FM simplex during the contest.

Bill Tynan, W3XO, editor of QST column World Above 50 MHz in cooperation with the ARRL has introduced a new kind of contest for VHFers. In an attempt to encourage and reward frequent activity on the bands, the new contest will be cumulative and run for an entire year (including days of major VHF/UHF contests).

Rule details appeared on page 83 of the December 1991 QST. The competition meets many of the proposals which VHFers have been looking for, ie: major incentives for higher frequency operation, power handicap, and incentives for distance. The competition is limited to single-operators only and points are easy to calculate. This program is worthy of a fair chance and may be a savior to the past low-activity levels of the VHF/UHF amateur bands. It is not Bill's or the League's wild idea. Rather, it is born in response to the concerns and input of the VHF weak-signal community nation wide. The program is intended to end the doldrums of inactivity which especially exists in clubs like the Pack Rats where hard work in microwave equipment construction often results in gear which has no power applied in the long months between major contests and band openings. Let's give the program an honest effort. Score forms will be available in Cheese Bits soon.

## SWAP SHOP

FOR SALE: AM6154 432 MHz linear amplifier. Uses 8930 final tube. 120/240 VAC power supply. 10 watts input - 300+ watts output. Converted for 432 operation by N3CX. Complete and in excellent operating condx. \$400. Another AM6154, converted for 432 MHz, less tube, \$250.

CONTACT: David Hackford, N3CX Tel: 215-679-7293 (h) 215-483-2030 (w)

WANTED: Long-boom, high-gain, 223 MHz yagi. To improve my sig in/out of W3CCX/R.

CONTACT: Dave Martin, WB8ZAR Tel: 717-366-2220

FOR SALE: TOWER, 70ft crank-up. Tri-EX HS-471. 4 sections, 440 lbs, 22ft nested requires guys. Tower is down and ready to haul. \$300.

CONTACT: John Sortor, KB3XG  
215-766-2643

FOR SALE: Cushman CE-2 communications analyzer, \$200. 384 MHz L.O., \$20.

CONTACT: Chuck Grabowski, WA2ONK  
609-586-7180 after 5 PM

WANTED: 432 MHz RF amplifier, 500+ watts. Also need 4-way power divider, etc.

CONTACT: Woody Peitzer, AK2F, 10 Berry Lane, Randolph, NJ 07869  
(201) 584-5709 (after 6:30 PM)

FOR SALE: Kenwood 3530 220FM xcvr, w/PL board, RF Concepts amp 2W input - 110W output, package deal \$500. 220 MHz 5/8 Larsen ant, \$20. Commodore C-64, disc drive, printer, joy sticks; 12" B/W mon, \$100. Icom IC-4AT 440 MHz HT, w/PL, batt, charger, \$180. Radio Shack DX-302 shortwave receiver \$80. 49 MHz FM headset xcvrs (2), \$80.

CONTACT: Marty, WB2GEZ Tel: 609-758-8865

FOR SALE: Henry Tempo 2002, 2KW 2-meter amp w/relays, \$600. Johnson-Viking 6N2 Thunderbolt amp, 1.5KW, \$600.

CONTACT: Harry Lucas, WA2KGM Tel: 716-657-7050

FOR SALE: Lunar 6-meter brick PA, 10W input - 100W output, \$100. Welz wattmeter, w/3 sensors on 3-50, 144-225, 200-450 MHz and power ranges 20, 200, and 2000 watts, \$75.

CONTACT: Wayne King, N2WK Tel: 716-638-8556

JOB WANTED: Position as electronics technician. Design and test experience in high power, high frequency, solid state RF. AAS in Electronics Engineering Technology. Four years experience in electronic troubleshooting. Will supply complete resume. References available.

CONTACT: Thomas Collins, KY2T 609-298-0019

## COMMERCIAL AD

LOOP YAGIS: 902 MHz 33 element \$89 kit, \$109 assembled and tested. 1296 MHz 45 element \$89 kit, \$109 assembled and tested. 1296 MHz 55 element "Super Looper" \$99 kit, \$124 assembled and tested. 2304 MHz 45 element \$75 kit, \$89 assembled and tested. Also available: element and hardware kits for above. 2 and 4-way power dividers. Discount on complete arrays. Solid state linear power amps, 13 VDC: 1296 - 8W in 35W out \$315, 1W in 20W out \$265, 4W in 70W out \$695. GaAs FET preamps: 902 MHz .8dB NF \$90, 1296 MHz .8dB \$90, 2304 MHz 1 dB max NF \$140. SHF SYSTEMS no-tune transverter kits, w/144 MHz IF now available for 903 through 3456 MHz. Write or call for complete catalog. DOWN EAST MICROWAVE, Bill Olson, W3HQT, Box 2301 RR-1, Troy, Maine 04907. For information and orders telephone (207) 948-3741.

## ARRL FILES FOR 222 MHZ PROTECTED ZONE

On November 12, the ARRL submitted a Petition for Rule Making to amend Section 97.201(b) and 97.205(b) to create a subband at 222.0 - 222.150 MHz for weak-signal communications. Such communications "require a certain amount of co-channel and adjacent-channel protection from other types of amateur operation, including repeater and simplex FM operation, due to the lower received signal strengths relative to other types of amateur operation", the petition said. The ARRL noted that similar subbands, where repeater operation is not permitted, exist at other bands, including 50.0-51, 144-144.5, 145.5-146, 431-433 and 435-438 MHz. In Docket 87-14, the League commented on the interesting results of Sporadic-E propagation conducted by amateurs at 220 MHz in 1987. "Those comments included an initial report of the first documented evidence of two-way sporadic-E communications at 220 MHz, between Dallas, Texas and Jacksonville, Florida," the ARRL told the FCC. "This type of scientific investigation is uniquely suited to the Amateur Radio Service, and necessitates a protected segment in order to be successful." Weak-signal operation that took place in 220-222 MHz has been completely displaced."

The ARRL acknowledged that repeater operations suffered from the loss of 220-222 MHz as well, including auxiliary links and some repeaters themselves below 222 MHz. But "in order for a weak-signal segment of the 222-225 MHz band to be created as herein proposed," ARRL said, "it may be necessary to relocate certain repeater operations, elsewhere in the band. A few may not be able to move, especially in Southern California, and many have to go off the air. "The alternative, however, is for large numbers of weak signal stations now displaced from 220-222 MHz to cease operation entirely. The ARRL believes it equitable, if not entirely satisfactory, for repeater operators to bear a small share of the loss of the 220-222 MHz segment in order to permit other types of amateur operation to continue in a relatively small 150 KHz segment of the 1.25 meter band." ARRL said that voluntary band planning would not be enough to ensure protection of weak-signal operation at 222 MHz, "in view of the previously entrenched nature of repeater and auxiliary operation there, and the extent of present crowding in the reduced band." A reasonable subband is of "critical importance," it said, to gain "scientific benefits" and "benefits in terms of technical self-training." TNX W5YI Report

### SOUTHERN CALIFORNIA REPEATER USERS OPPOSED

The proposed weak-signal subband on 222 MHz has brought southern California repeater users out swinging. Citing 18 existing repeaters which would be forced to cease operation under the new rule, Karl Pagel, N6BVU, states "the ARRL took upon itself, without first asking its members nationwide, to create a special subband for weak-signal experimenters that could not be used for repeater or remote base input or output frequencies." "It would have been easier just to have the weak-signal users ask a few of the repeater owners to turn off their systems for a couple of [contest] weekends a year". Burt Hicks, WB6MQV, editor of Westlink Report writes "Unless someone can convince us that there is some practical purpose in 'fine tweaking' our technical expertise in low power CW or SSB, or in EME work at these particular frequencies, we must consider several things. First, most of these specialized activities take place on 144 and 432 MHz." The FMers claim that there are only a few hundred experimental users of the 1.25 meter band in the whole nation, while there are tens of thousands FMers, with a few hundred of them using this spectrum just in Southern California. They say that a mass resignation of FM interests will financially hurt the ARRL and force it to rescind the reallocation request. "If not," says another 222 MHz FMer, "there is always the federal courts." The FMers are screaming that the ARRL has "sold them out". WLEJ and other 222 MHz weak-signal ops claim that the proposed 150 khz is not enough. We're fighting each other with the ARRL in the middle. TNX Westlink Report.

## RECEIVE MIXER/DIPLEXER FILTER AND POST-AMP

Portions of a companion 50 MHz receive converter have been published recently in Cheesebits; the remaining circuits are described here. The heart of the receive converter is the Mini-Circuits high level SRA-1H mixer, identical to that used in the transmit converter.<sup>1</sup> The SRA-1H requires a 50 mW (+17 dBm) LO as previously described.<sup>2</sup>

Commercial double-balanced mixers (DBM) are easy to use and offer significant performance advantages compared to single-ended mixers. While most transverter designs use the "standard level" DBM's requiring a +7 dBm LO, the use of a high level mixer (+17 dBm LO) allows larger signals to be handled without generating distortion. Optimum performance from a double-balanced mixer (DBM) requires that the IF port "sees" a good 50 ohm match over a broad bandwidth, including the LO, RF, and IF frequencies. The common practice of connecting a narrowband bandpass filter (BPF) directly to the IF port severely degrades the distortion characteristics of a DBM! To correct this problem a diplexer filter may be used at the IF port, followed by a post amp and BPF. This arrangement presents a broadband match to the mixer's IF port, thereby enhancing the overall receiver performance.

Since the conversion gain placed in front of an IF receiver will directly reduce the IF's dynamic range, or ability to handle strong signals, attention to gain is important. For best performance the overall receiver conversion gain should be 20 dB or less. If a 28 MHz post-amp is found necessary with the receiver you're using, the circuit shown may be used. Gain is a moderate 15 dB and the compression point and distortion characteristics are better than those of a MMIC having the same gain. Feedback is used to obtain a broadband input return loss while ensuring stable operation. A BPF follows the post-amp.

### REFERENCES

1. "SRA-1H High Level Mixer," WB3JYO, Dec 90 Cheesebits.
2. "A 22 MHz Oscillator Chain," WB3JYO, Nov 90 Cheesebits.

WB3JYO 12-91

# RECEIVER MIXER AND DIPLEXER FILTER

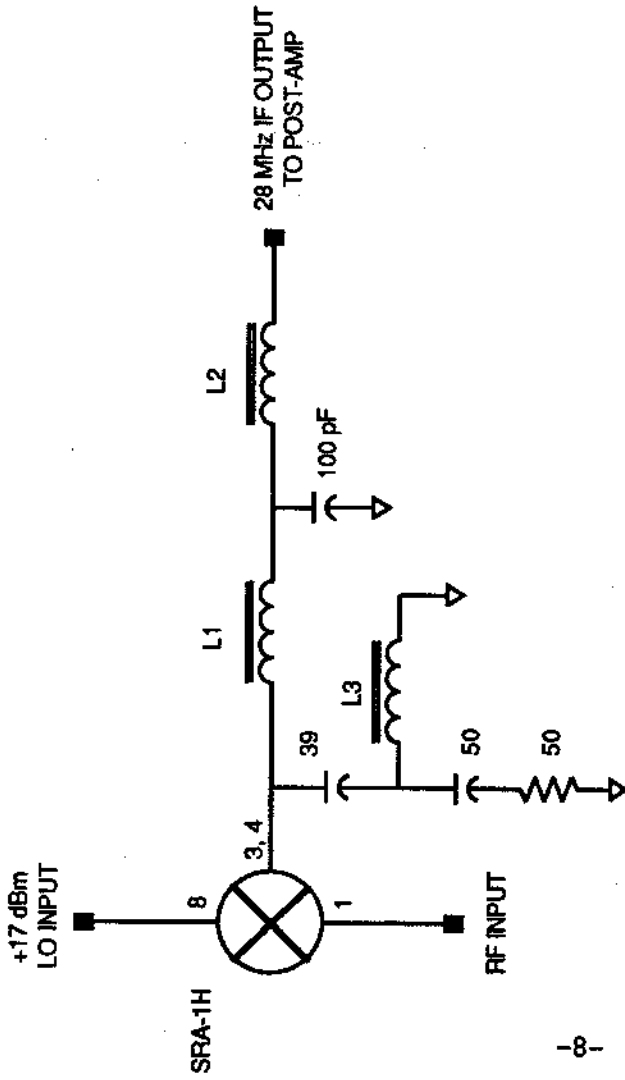

NOTE: PINS 2,5,6,7 TO GND.

- L1 .35 uH, 5 t #24 enam. on T50-6 toroid
- L2 .21 uH, 4 t #24 enam. on T50-6 toroid
- L3 .18 uH, 4 t #24 enam. on T37-6 toroid

A diplexer filter follows a Mini-Circuits SRA-1H high-level mixer providing a broadband 50 ohm resistive match for improved third order distortion characteristics. An optional 28 MHz post-amp may follow.

MINI-CIRCUITS SRA-1H



TOP VIEW

|     |                        |
|-----|------------------------|
| LO  | 8                      |
| RF  | 1                      |
| IF  | 3,4 (CONNECT TOGETHER) |
| GND | 2,5,6,7                |

BLUE BEAD INDICATES PIN 1

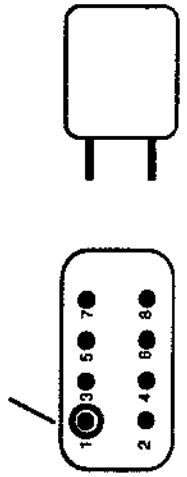



# 28 MHZ LOW-DISTORTION POST AMPLIFIER

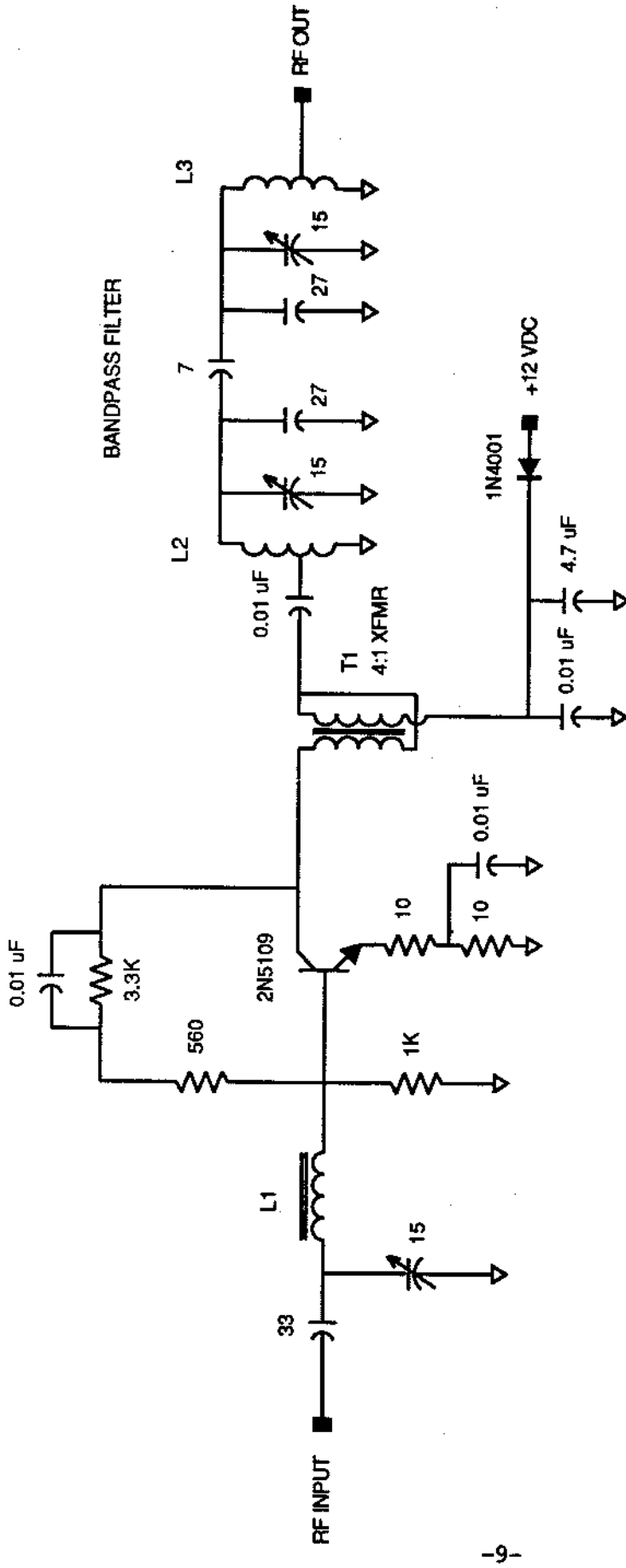

## NOTE

CAPACITANCE IN pF UNLESS NOTED.

USE PUSH-ON TYPE HEATSINK ON 2N5109

L1 15# 26 ENAMEL ON T37-6 TOROID

L2, L3 15# 26 ENAMEL ON T37-6,  
TAP AT 4# FROM GROUND

T1 20# 30 BIFILAR ON T37-10 TOROID.  
CONNECT TRANSFORMER AS SHOWN.

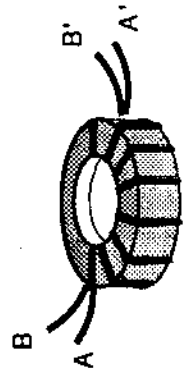

2N5109

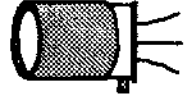

HEATSINK MADE FROM COPPER

GAIN = 15 dB @ 28 MHz  
Icq = 60 mA  
P1dB = +23dBm  
Third Order Intercept Point = +32 dBm  
STABLE INTO 10:1 VSWR

WB3JYO 12-91

# 1989 CONTEST CLOCK

(STILL ACURATE IN 1992!)

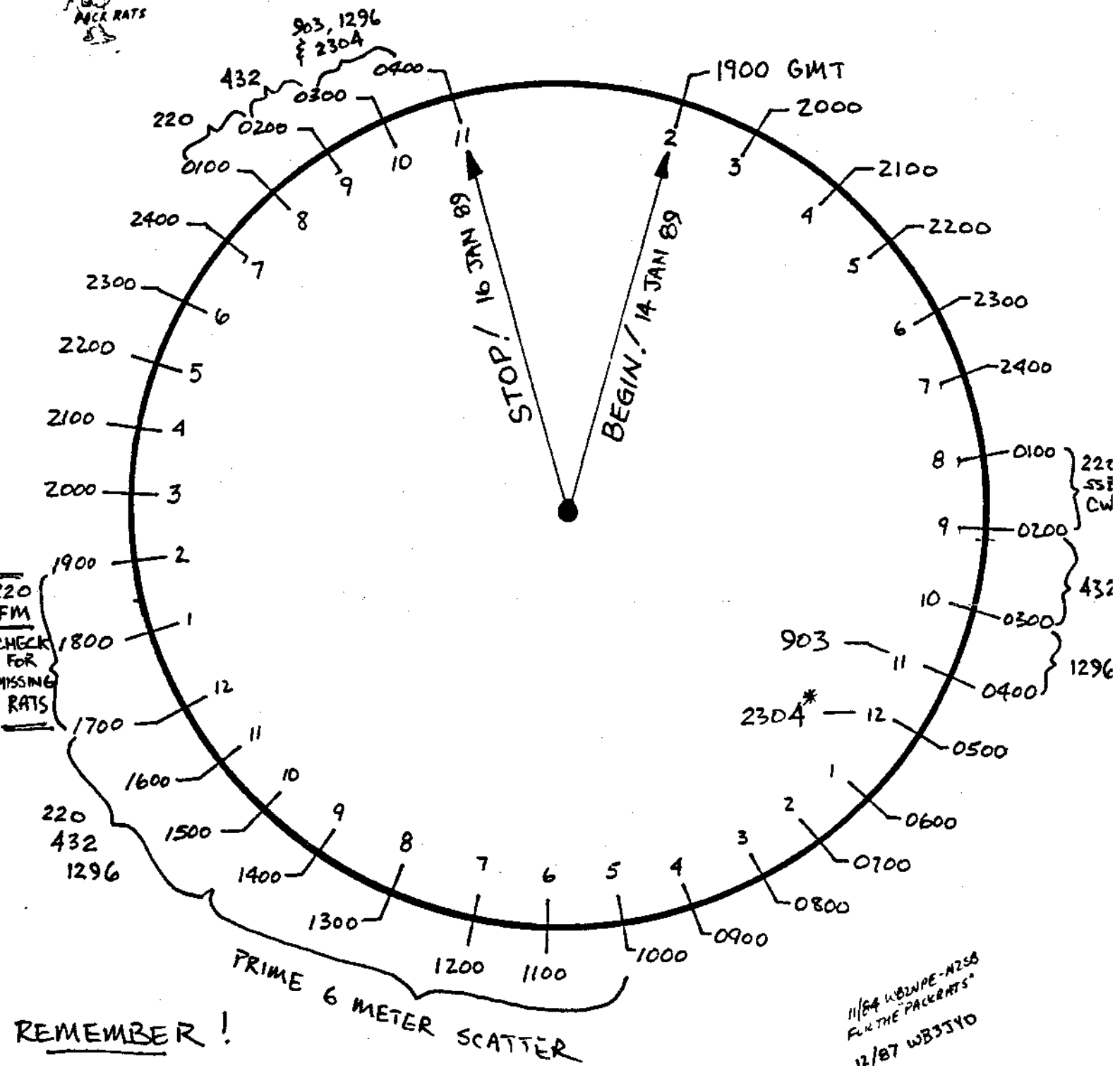

## REMEMBER!

- WORK ALL PACKRATS ON ALL POSSIBLE BANDS
- CHECK 6 AND 2 AT SUNRISE, NOON, SUNSET FOR DX
- EAT AND DRINK RIGHT. GET SOME SLEEP
- DO YOUR BEST. WORK HARD. USE YOUR STATION TO ITS MAXIMUM CAPABILITY! EVERY PACKRAT SHARES THE GAVEL; EVERY PACKRAT'S EFFORT IS VITAL. ABOVE ALL, HAVE FUN!

11/84 W2NPE-N258  
FOR THE "PACKRATS"  
12/87 WB3JYO  
\* 223.42 MHz  
COORDINATION FREQ.

# DOWN EAST MICROWAVE

MICROWAVE ANTENNAS AND COMPONENTS

BILL OLSON  
W3HQ7

BOX 2310 RR1  
TROY, ME 04987  
(207) 948-3741

FRANCIS HENDERSON  
N8DJB

Ph. (419) 352-4465  
Hrs. 10-5



C. A. T. S.  
Rotor Parts & Repair



7368 S.R. 105

Pemberville, OH 43450

215-288-0325



# W3HK

GEORGE S. VanDYKE, JR. P.E.

1737 Scattergood St.  
Phila., PA 19124

## The R.F. Connection "Specialists in RF Connectors and Coax"

KA3QPG  
Joel Knoblock  
301/840-5477  
Fax 301/869-3680

Order Line 800-783-2686  
Suite 11, 213 N. Frederick Ave.  
Gaithersburg, MD 20877

(302) 328-7728  
ORDER LINE 800-441-7008



### Delaware Amateur Supply

"AMATEUR SALES AND SERVICE"

PAUL WA3QPX  
KATHY KA3LYO

71 MEADOW ROAD  
NEW CASTLE, DELAWARE 19720

(215) 856-8800 DAY  
(215) 343-2448 NIGHT

INDUSTRIAL  
COMMERCIAL  
RESIDENTIAL

### WARRINGTON ALARM CO.

LOCKSMITH • BURGLAR • FIRE

BOB HERSHMAN

417 DAVISVILLE ROAD  
WILLOW GROVE, PENNA. 19090-3483

215-342-5982

WA3HIT

Paul and Betty Rilling

INCOME DIVERSIFICATION

5830 Weymouth Street -Phila., Pa.19120

Gerry Rodski - K3MKZ

717-868-5643  
6-10 PM

SSB ELECTRONIC U.S.A.  
Call for Catalog

124 Cherrywood Dr. Mountaintop, Pa 18707

609-541-0120

### Bob Fischer Company, Inc.

AERIAL LADDERS • UTILITY EQUIPMENT

BOB FISCHER  
PRES.

28TH & LINCOLN AVE.  
CAMDEN, N. J. 08105

## ZD Engineering

Specialists in CATV Hardline  
Matching Transformers-Power Dividers  
and Related R.F. Devices

144 MHZ-1296 MHZ...

TO FIT 1/2, 3/4 AND 7/8 INCH HARDLINE.

PAUL H. DARWACTOR  
(419) 424-8785

W8ZD

605 Balsey Ave.  
Findlay, Ohio 45840

## DESTINATIONS INC.

A FULL SERVICE TRAVEL AGENCY

HARRIET SOLTOFF  
TRAVEL CONSULTANT

616 SOUTH THIRD STREET  
PHILADELPHIA, PA. 19147

RES. (215) 947-4483

MONDAY-THURSDAY 7:00-8:00  
SAT. 9:00-4:00

Day-Nite (215) 455-2121

## FERTIK'S ELECTRONICS . . . .

Components & Equipment

LEON FERTIK

5400 BLA STREET  
PHILADELPHIA, PA. 19120

# ARROW

RICHARD E. COMLY

TOOL, DIE & MACHINE CO., INC.  
2065 BENNETT RD. PHILA., PA 19116



(215) 676-1300  
FAX 934-5237

(809) 268-0736

RICHARD CONNOR



## RECON Communications

- COMMUNICATIONS TOWER MAINTENANCE
- ANTENNAS, FEEDLINES, TOWERS INSTALLED
- TOWER PAINTING, RE-LAMPING, RE-GUYING
- RF SYSTEM TROUBLESHOOTING
- LIGHTNING PROTECTION, GROUND SYSTEMS

Emergency Service

412 Carranza Road  
Tabernacle, NJ 08068

(302) 328-7728  
ORDER LINE 800-441-7008



### Delaware Amateur Supply

"AMATEUR SALES AND SERVICE"

ROB WA3QLS  
GAIL KA3ITN

71 MEADOW ROAD  
NEW CASTLE, DELAWARE 19720

(215) 745-5173  
(302) 886-7630  
(215) 342-6832



### COMPU-SIMPLE, INC.

COMPUTER APPLICATIONS FOR SMALL BUSINESS

ELLIOTT J. WEISMAN  
Consultant

P.O. BOX 7161  
WILMINGTON, DELAWARE 19803

## RUTLAND ARRAYS

For the finest VHF/UHF antennas  
1703 WARREN ST.  
NEW CUMBERLAND, PA 17070

Call or write for our new catalog!  
(717) 774-5298 7 - 10 pm EST

### Hopkins & Yampolsky, P.C.

ATTORNEYS AND COUNSELLORS AT LAW  
1814 SPRUCE STREET  
PHILADELPHIA, PENNSYLVANIA 19103

STEVEN N. WHITE  
WA3LAO

TEL. (215) 545-1300

PACK RATS

FIRST CLASS

DICK HUNTZINGER  
W3FGD  
130 FAIRHILL RD.  
CHURCHVILLE, PA 18966

N 12/92

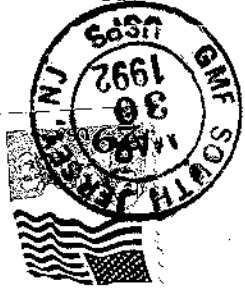

MT. AIRY  
VHF  
RADIO  
CLUB,  
INC.

MEETING  
NOTICE

Cheese Bits  
412 Carranza Rd  
Tabernacle, NJ  
08088

ICOM

CES  
SEI

Saxton

CDE

n-te

GILFER  
LMB

TPL

B

Weller

DRAKE

Miller  
hygain

ASTATIC

CALLBOOK

waldom

Manley

communications specialists

Larsen Antennas

"W2AU"

HAM-KEY

ROHN

If we're  
judged by the  
company we  
keep, we should  
do pretty well!



"HAM" BUERGER, INC.  
Electronic Equipment Distributor

"Right in the middle of a lot of good company!"

417 DAVISVILLE ROAD  
WILLOW GROVE, PA 19090  
215-659-5900

Service Since  
1956

BIRD

MISCO

Vector

DATA

HUSTLER

phelps  
dodge  
Communications Company

MAJ

AMCO

BOMAR

VIBROPLEX

NPC

TEN-TEC

TRW

TAB BOOKS  
Regency

SWAN

COVER CRAFT

AMP  
SPECIAL  
INDUSTRIES

Sonnet

Cushcraft  
AMPHENOL

SPW

ICR

WESCAM

TELEX

SPRAGUE

Xcelite

Wilson Electronics Corp.